

www.fujipoly.com

SARCON[®] THERMAL INTERFACE MATERIALS

Creating unprecedented products with unprecedented performance.



FUJIPOLY COMPANY POLICY

Create values, promote social action and our employees' satisfaction.

Operational Guideline

" Customer Satisfaction is Primary "

Provide safe products, satisfying our customers needs, while making quality the core of our management.

Provide environmentally friendly products based on silicone rubber technology.

Distribute our products to a wide base of customers, through our expanding global network.

Provide globally competitive products by continued improvement in manufacturing technology and productivity.

Through the development of creative new products, we will strive to be number one in the markets we serve worldwide.

"Take Responsibility"

Grow the company productively and continuously with customer and employees' satisfaction.

" Respecting the Dignity of the Individual "

The work environment will encourage individual self-fulfillment and the maximization of skills and talents.

The work environment will be safe and clean and protect the natural environment.

The work environment will foster open communication and the free exchange of information and ideas.

Fuji Polymer Industries Co., Ltd. was established in 1978 as a manufacturer specializing in the secondary processing of industrial silicone rubber products on the technological foundation of Dow Corning of the United States, the largest silicone producer in the world. We have steadily grown during the course of time since then. It has only been fifty years since the organometallic polymer, silicone, appeared in the world, but it has become an indispensable material in a wide variety of fields because of its superlative characteristics. We are proud to be helping to meet the demand for this excellent material.

In the manufacturing industry where great technological innovations have followed one after another, we have always devoted ourselves to developing and supplying only those products that would meet the needs of the time. As a result, we had first acquired new markets within the automotive, heavy electric machinery, and home electric appliance industries, and then expanded into the electronics field including office automation, optical and visual equipments. From the beginning of our establishment, we have, from a global viewpoint, pursued technological tie-ups and distribution agreements with overseas companies.

We have also established production bases abroad through various means including mergers and acquisitions. All these activities have been based on our borderless business strategy, which we have adopted in anticipation of the ongoing trend of so-called globalization. Our basic idea of business is not limited to the supply of silicone rubber products as substitutes or replacements for existing products or parts. Creating unprecedented landmark products from silicone rubber to meet the demands of the times-this is what governs us in all our manufacturing activities. On the overseas front, we wish to become an enterprise that can contribute to the world economy and society as a member of the international community, keeping close communication and relationships with people all over the world upon equal terms. Your kind support and continued patronage will be greatly appreciated.

President

LINE UP

	Construct	Feature
SARCON® RUBBER TYPE	<ul style="list-style-type: none"> ■ Silicone Rubber ■ Inorganic Thermal Conductivity Filler 	SARCON Rubber Type based materials offer other useful elements such as electrical insulation, protective coverings and gasketing as integral features in most designs. ▶ P. 09-12
SARCON® GAP FILLER TYPE	<ul style="list-style-type: none"> ■ Silicone Rubber ■ Inorganic Thermal Conductivity Filler 	SARCON Gap Filler Type is supplied in a fully cured state and remain pliable, easily conforming to minute surface irregularities. Therefor SARCON Gap Filler Type can be further enhanced for special handling and die-cutting requirements. ▶ P. 13-16
SARCON® EXTREMELY COMPRESSIBLE GAP FILLER TYPE	<ul style="list-style-type: none"> ■ Silicone Rubber ■ Inorganic Thermal Conductivity Filler 	SARCON Extremely Compressible Gap Filler Type is easy to flow and fill gaps with low compression force at high compression rate. ▶ P. 17-20
SARCON® FORM IN PLACE GAP FILLER TYPE	<ul style="list-style-type: none"> ■ Silicone material ■ Inorganic Thermal Conductivity Filler 	SARCON Form In Place Gap Filler Type is highly conformable with very low compression forces. Therefor SARCON Form in Place Gap Filler Type is suitable for filling the delicate gaps and still provide superior thermal transfer. ▶ P. 21-22
SARCON® NON-SILICONE TYPE	<ul style="list-style-type: none"> ■ Non-Silicone Rubber ■ Inorganic Thermal Conductivity Filler 	SARCON Non-Silicone Type is highly conformable, thermally conductive, non-flammable acrylate resin (non-silicone) sheet. ▶ P. 23
SARCON® ELECTROMAGNETIC WAVE ABSORPTION TYPE	<ul style="list-style-type: none"> ■ Silicone Rubber ■ Ferrite ■ Inorganic Thermal Conductivity Filler 	SARCON Electromagnetic Wave Absorption Type is effective to absorb and damp range of electromagnetic waves, also effective as a high performance thermal interface material. ▶ P. 24
SARCON® GREASE TYPE	<ul style="list-style-type: none"> ■ Silicone material ; SG 07SL/SG 26SL ■ Non-Silicone material ; SG 07NS/SG 26NS/SG 42NS ■ Inorganic Thermal Conductivity Filler 	SARCON Grease Type ensure the lowest amount of bleed and evaporation. ▶ P. 25

CONTENTS

Introduction	▶ P. 01-08
Function	▶ P. 09-25
Volatile Components of SARCON® series	▶ P. 26
Compression Force	▶ P. 27-28
Thickness of SARCON® materials	▶ P. 29-30
TEST Method	▶ P. 31-34
Fujipoly Technology	▶ P. 35-36
Ordering Information	▶ P. 37-38

SARCON® Selection Guide

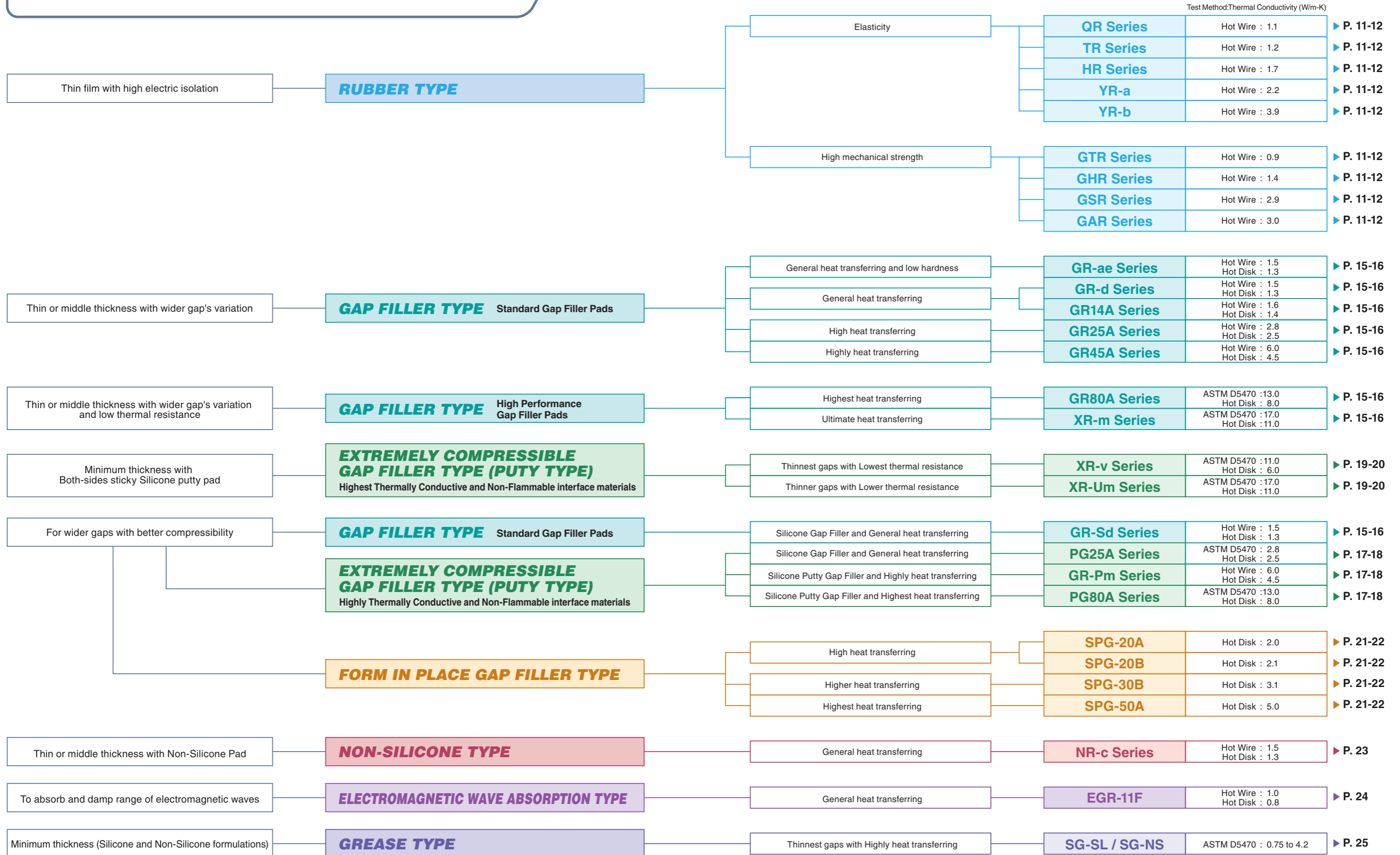

ASTM D5470: Measured by ASTM D5470 modified, refer to Fujipoly Test method "FTM-P3030". → See P.32

SARCON® Selection Guide

SARCON® Thermal Conductivity List

Thermal Conductivity (W/mK)	RUBBER TYPE	GAP FILLER TYPE	EXTREMELY COMPRESSIBLE GAP FILLER TYPE	FORM IN PLACE GAP FILLER TYPE	NON-SILICONE TYPE	ELECTROMAGNETIC WAVE ABSORPTION TYPE
0.8						EGR-11F (1.0W/mK)*1
0.9	GTR					
1.1	QR					
1.2	TR					
1.3		GR-ae GR-d GR-Sd (1.5W/mK)*1			NR-c (1.5W/mK)*1	
1.4	GHR	GR14A (1.6W/mK)*1				
1.7	HR					
2.0				SPG-20A		
2.1				SPG-20B		
2.2	YR-a					
2.5		GR25A (2.8W/mK)*1	PG25A (2.8W/mK)*1			
2.9	GSR					
3.0	GAR					
3.1				SPG-30B		
3.9	YR-b					
4.5		GR45A (6.0W/mK)	GR-Pm (6.0W/mK)			
5.0				SPG-50B		
6.6			XR-v (11.0W/mK)*1			
8.0		GR80A (13.0W/mK)*1	PG80A (13.0W/mK)*1			
11.0		XR-m (17.0W/mK)*1	XR-Um (17.0W/mK)*1			

Measured by using Hot Disk method, refer to Fujipoly Test method "FTM P-1612". →See P.31
 Rubber Type , *1 : Measured by using Hot Wire method, refer to Fujipoly Test method "FTM P-1620". →See P.31
 *1 : Measured by using ASTM D5470 modified, refer to Fujipoly Test method "FTM P-3030". →See P.32

SARCON® Thermal Resistance Data

Clamping Torque : 0.69Nm (0.51lbf-ft)

RUBBER TYPE

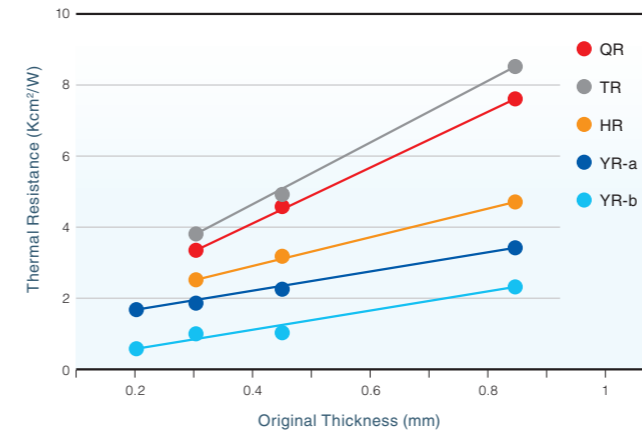

RUBBER TYPE with Glass Fiber Cloth

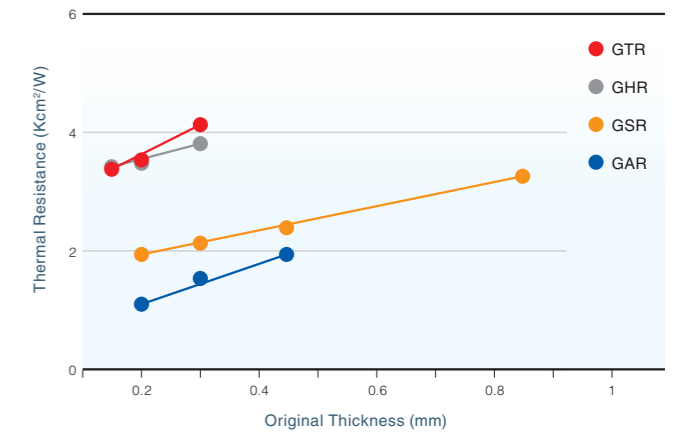

Measured by using Fujipoly Original (TO-3 package), refer to Fujipoly Test method "FTM P-3010". →See P.33

Pressure : 500kPa (72.5psi)

GAP FILLER TYPE

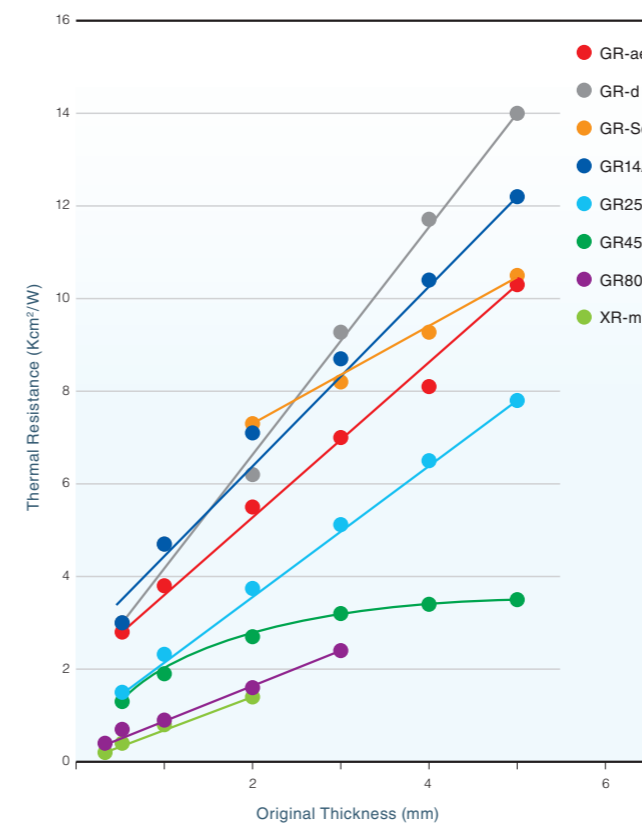

EXTREMELY COMPRESSIBLE GAP FILLER TYPE

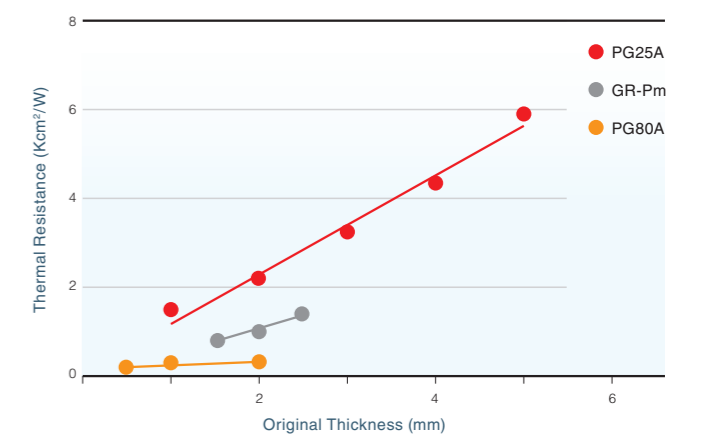

EXTREMELY COMPRESSIBLE GAP FILLER TYPE

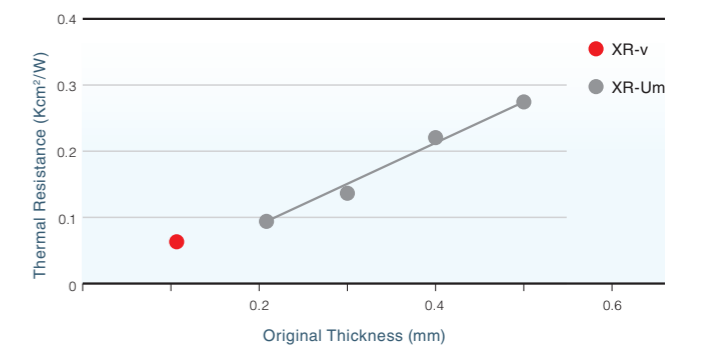

Measured by using ASTM D5470 equivalent (TIM tester 1300), refer to Fujipoly Test method "FTM P-3050". →See P.32

Original Thickness is the initial thickness of SARCON before pressing.

Thermally Conductive / Non-Flammable Silicone Rubber

“SARCON®”

Our unique product, SARCON® is an advanced silicone rubber with high thermal conductivity and superior flame retardancy.

Functions

As shown below, even the most highly polished mating surfaces do not make reliable contact surfaces. Complete physical contact is necessary to minimize the resistance to heat flow for the best thermally conductive path. Such surface voids, when properly filled with a conformable, SARCON, will in most cases exhibit the continuous characteristics of a solid metal of the same dimensions.

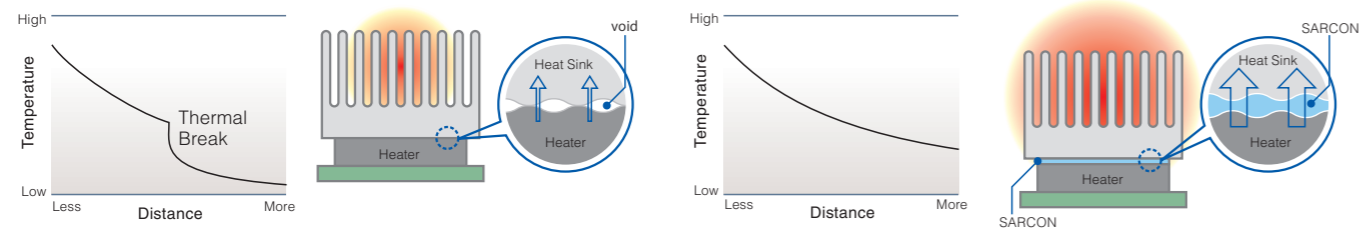

Thermal resistance of semiconductor mounted to substrate is appreciably increased at junction of porous surfaces.

Thermal resistance of semiconductor mounted to substrate with gap filler pad is eliminated yielding higher temperature gradient.

Flame Retardant

UL File Number: E58126

Applications

- Thermal conductive insulators for semiconductors
- Compression jointing materials for thermistors and temperature sensors
- Thermal conductive material for all types of heaters

Formulations/Configurations

- A variety of specific compounds are available for a wide range of performance requirements in Sheets, Rolls, Die-cuts, Sleeves, Gel, Extrusions, Moldings

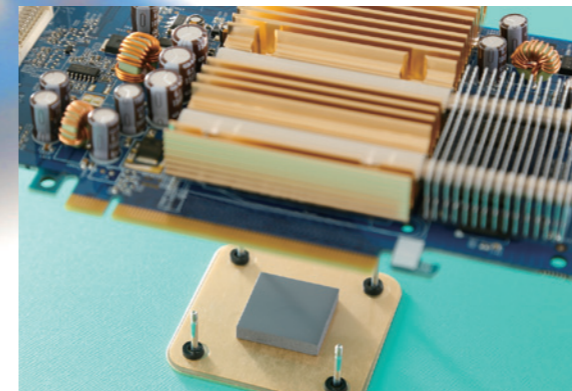

SARCON's versatility in thermal management applications is doubly enhanced by way of the variety of end-use configurations possible, and the many standard material formulations available in each.

The silicone rubber based materials offer other useful elements such as electrical insulation, protective coverings and gasketing as integral features in most designs.

Along with a few simple recommendations to help in obtaining the optimum performance for your application, a few suggestions are included which may help you to take advantage of some of these other features.

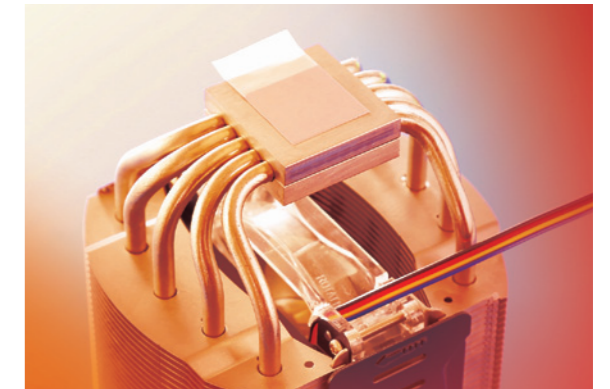

More power and light weight. In the past, these two characteristics in electronics were mutually exclusive. Now, micro-electronics are just that, and in addition, need thermal management components to further complement these objectives.

SARCON is an advanced silicone rubber with high thermal conductivity and superior flame-retardancy. By combining the inherent silicone rubber properties of heat resistance, electrical insulation and long-term aging into one compound, this universally applicable material can be made in an unlimited number of thermal management configurations.

THERMAL TRANSFER

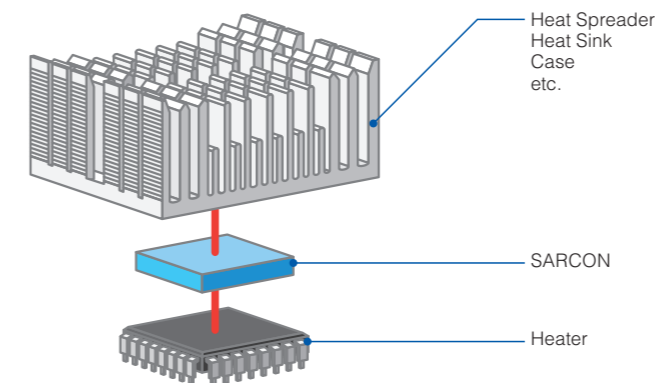

- Consider the most efficient SARCON materials regarding thermal conductivity.
- Take advantage of the heat transfer characteristics of any nearby sheet metal, heat sink and case components by using the SARCON component as a thermally conductive bridge from Heater to Heat Sink. See drawing at left.
- Note also that SARCON is very elastic, providing a very tight fit over uneven surfaces. This eliminates the need for gap-filling agents in order to achieve high rates of thermal dissipation without variation. The sleeves and cases can be designed as an interface fit which can slip snugly over appropriately configured components.

Attachment

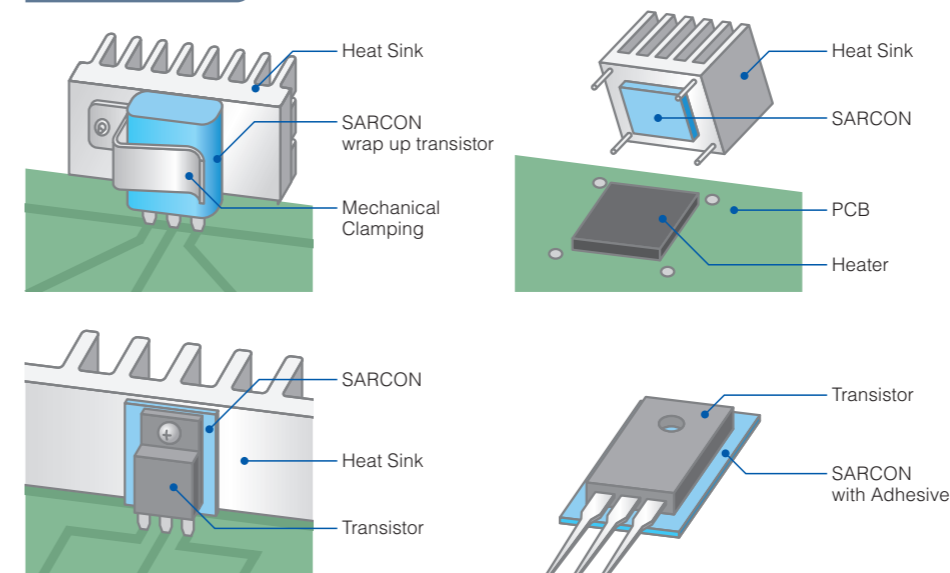

- No special preparations are necessary to attach the SARCON component.
- Some of the most common alternatives include:
 - Pressure Sensitive Adhesive
 - Silicone Adhesive
 - Mechanical Clamping
 - Hardware Attachment / Screws, rivets
 - Self-Adhering Silicone Gel

SARCON® RUBBER TYPE

Thin Film with High Electric Insulation

SARCON® Rubber type developed by our original studies are the epoch-making silicone rubber products with high insulative and thermally conductive properties as well as a high flame resistant or non flammable property.

Features

- Has a thermal conductivity and excellent electrical insulation properties.
- Available for tubes, tapes, Cases and Die-cut Gaskets shapes to meet a various application (Shown on Page10 of Configuration).
- GTR, GHR, GSR, GAR; Heat conductive silicone rubber within Glass Fiber Cloth has excellent mechanical and physical characteristics.
- UL94 V-0 certified (with exceptions).
- Available with an Adhesive option.

Recommended Application

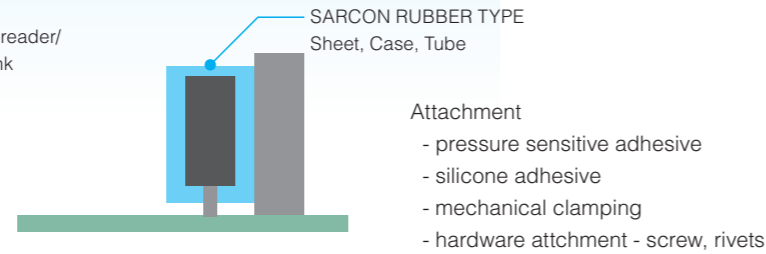
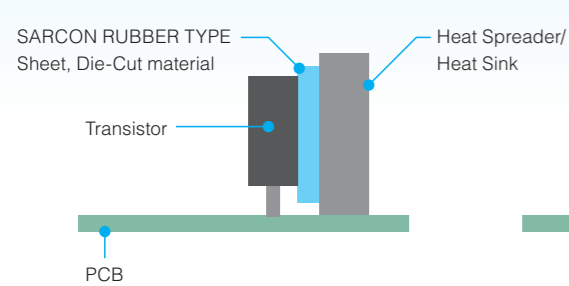

Clamping Torque

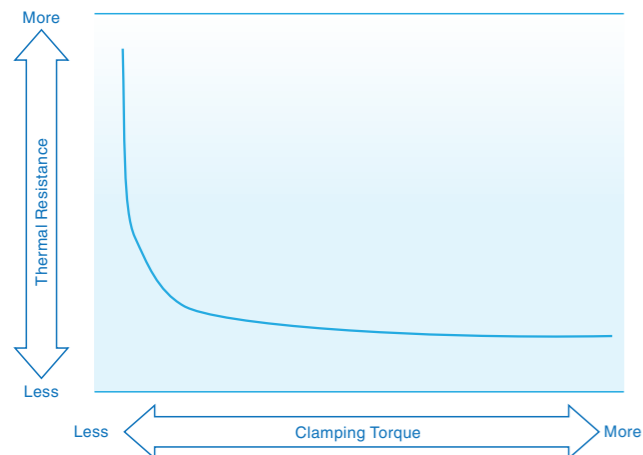

- Clamping torque of the installed SARCON Rubber : Thermal resistance decrease as the torque is increased.
- Test method : Fujipoly Test Method FTM P-3010 by TO-3 package

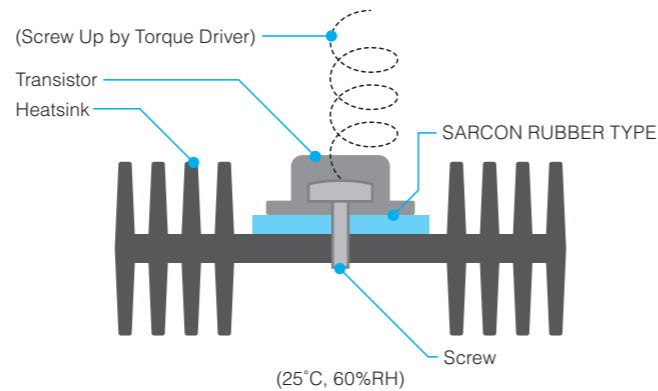

Configuring a Part Number of Rubber Type

30 GSR -AD - Width(mm) × Length(mm)

Thickness	Series	Option
15 = 0.15mm	Q = QR	blank = without
20 = 0.2mm	T = TR	-AD = Adhesive Coating
30 = 0.3mm	H = HR	
45 = 0.45mm	Y-a = YR-a	
55 = 0.55mm	Y-b = YR-b	
65 = 0.65mm	GTR = GTR	
75 = 0.75mm	GHR = GHR	
85 = 0.85mm	GSR = GSR	
	GAR = GAR	

available to Adhesive Coating option : GTR,GHR,GSR

Configuration

SARCON RUBBER TYPE's versatility in thermal management applications is doubly enhanced by way of the variety of end-use configurations possible, and the many standard material formulations available in each.

The silicone rubber based materials offer other useful elements such as electrical insulation, protective covering and gasketing as integral features in most designs.

	Color	Form				Hardness (IRHD)	Thermal Conductivity (W/m-k) by using Hot Wire
		Tape	Sheet	Tube	Case		
TR	Greenish Gray	○	×	○	○	75	1.2
HR	Brown	○	×	○	○	85	1.7
QR	Black	○	×	○	○	55	1.1
GTR	Greenish Gray	○	○	×	×	87 (20GTR)	0.9
GHR	Brown	○	○	×	×	92 (20GHR)	1.4
GSR	White	×	○	×	×	90 (20GSR)	2.9
GAR	White	○	○	×	×	80 (20GAR)	3.0
YR-a	Dark Gray	○	×	○	×	81	2.2
YR-b	Gray	○	×	×	×	65	3.9

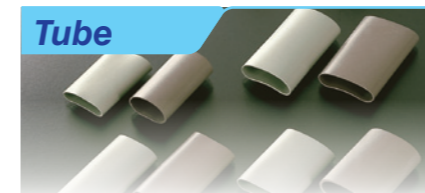

Tube shapes available in three thicknesses. TR, HR or UR formulations. The flexible structures conform to most applications. All standard items in stock; custom lengths and diameters available.



Flat stock in rolls or single sheets for your custom finishing. Can be diecut or trimmed to any proprietary shape on your finishing equipment. Available in five thicknesses and all SARCON formulations.

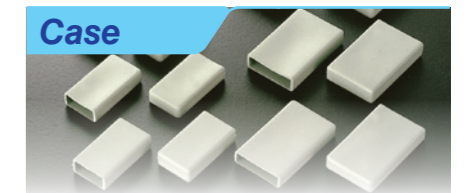

Box-shaped caps for transistors. High thermal dissipation rate. Open on one end; installs by just slipping over the desired components. Available in TR and HR materials. All standard items in stock; custom sizes available.



Standard die-cut parts. Effective also as a mounting cushion to prevent deformation. Custom designs available in unlimited sizes and shapes.

Custom - Rubber Extrusions

SARCON E Mold products are co-extruded products of highly thermally conductive and non-flammable silicone rubber, SARCON, and available in various shapes and designs.

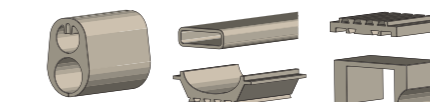

AD series

Available to Adhesive Coating option: GTR, GHR, GSR, GAR

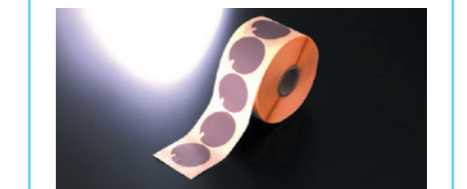

Construction

TR
HR
QR

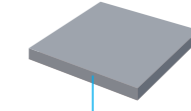

Plain Type

GTR
GHR
GSR
GAR

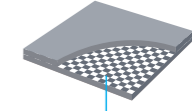

with Glass Fiber Cloth

Typical Product Properties

Test Properties	Unit	GTR			QR			TR			GHR			HR			YR-a				GSR				GAR			YR-b			
		15GTR	20GTR	30GTR	30Q	45Q	85Q	30T	45T	85T	15GHR	20GHR	30GHR	30H	45H	85H	20Y-a	30Y-a	45Y-a	85Y-a	20GSR	30GSR	45GSR	85GSR	20GAR	30GAR	45GAR	20Y-b	30Y-b	45Y-b	85Y-b
Physical Properties	Adhesive Coating	-																													
	Thickness*	mm																													
	Specific Gravity	-																													
	Hardness	IRHD																													
	Color	-																													
	Tensile Strength	MPa																													
Electrical Properties	Volume Resistivity	Ohm-m																													
	Breakdown Voltage	kV / Thickness																													
	Dielectric Strength	kV / Thickness																													
		50Hz																													
		1kHz																													
	Dissipation Factor	50Hz																													
1kHz																															
1MHz																															
Thermal Properties	Thermal Conductivity	W/m-K																													
	Recommended Operating Temp.	°C																													
		°F																													
Flame Retardant	UL94																														

a) Hardness : The highest value by using IRHD.
 b) Thermal Conductivity : Measured by using Hot Wire method, refer to Fujipoly Test method "FTM P-1620". → See P.31
 c) Tensile Strength / Elongation on QR, TR, HR, YR-a, YR-b, according to ASTM D412.
 d) Tensile Strength / Elongation on GTR, GHR, GSR, GAR according to ASTM D1458, Fully Cured Silicone Rubber - Coated Glass Fabric Cloth.

* Some details of thickness → See P.29

Clamping Torque versus Thermal Resistance

unit : K-cm²/W (K-in²/W)

Clamping Torque	QR			TR			HR			YR-a				YR-b				GTR		
	30Q	45Q	85Q	30T	45T	85T	30H	45H	85H	20Y-a	30Y-a	45Y-a	85Y-a	20Y-b	30Y-b	45Y-b	85Y-b	15GTR	20GTR	30GTR
0.29Nm / 0.22lbf-ft	3.94 (0.61)	5.35 (0.83)	9.16 (1.42)	4.19 (0.65)	4.90 (0.76)	8.84 (1.37)	2.84 (0.44)	3.48 (0.54)	4.90 (0.76)	1.81 (0.28)	2.16 (0.34)	2.52 (0.39)	3.97 (0.62)	0.84 (0.13)	1.39 (0.22)	1.45 (0.23)	2.87 (0.45)	3.74 (0.58)	3.87 (0.60)	4.39 (0.68)
0.49Nm / 0.36lbf-ft	3.68 (0.57)	4.97 (0.77)	8.06 (1.25)	4.00 (0.62)	4.71 (0.73)	8.71 (1.35)	2.71 (0.42)	3.35 (0.52)	4.77 (0.74)	1.74 (0.27)	1.94 (0.30)	2.26 (0.35)	3.61 (0.56)	0.68 (0.11)	1.16 (0.18)	1.16 (0.18)	2.52 (0.39)	3.29 (0.51)	3.61 (0.56)	4.26 (0.66)
0.69Nm / 0.51lbf-ft	3.35 (0.52)	4.58 (0.71)	7.61 (1.18)	3.81 (0.59)	4.58 (0.71)	8.52 (1.32)	2.52 (0.39)	3.29 (0.51)	4.71 (0.73)	1.68 (0.26)	1.77 (0.28)	2.10 (0.33)	3.42 (0.53)	0.58 (0.09)	1.00 (0.16)	1.03 (0.16)	2.32 (0.36)	3.23 (0.50)	3.48 (0.54)	4.13 (0.64)

Clamping Torque	GHR			GSR				GAR		
	15GHR	20GHR	30GHR	20GSR	30GSR	45GSR	85GSR	20GAR	30GAR	45GAR
0.29Nm / 0.22lbf-ft	3.74 (0.58)	3.94 (0.61)	4.32 (0.67)	2.00 (0.31)	2.39 (0.37)	2.58 (0.40)	3.35 (0.52)	1.29 (0.20)	1.81 (0.28)	2.12 (0.33)
0.49Nm / 0.36lbf-ft	3.55 (0.55)	3.68 (0.57)	3.94 (0.61)	1.94 (0.30)	2.19 (0.34)	2.52 (0.39)	3.29 (0.51)	1.10 (0.17)	1.68 (0.26)	1.94 (0.30)
0.69Nm / 0.51lbf-ft	3.42 (0.53)	3.48 (0.54)	3.81 (0.59)	1.94 (0.30)	2.13 (0.33)	2.39 (0.37)	3.26 (0.50)	1.10 (0.17)	1.68 (0.26)	1.94 (0.30)

e) Measured by using Fujipoly Original (TO-3 package), refer to Fujipoly Test method "FTM P-3010". → See P.33

Test Properties	Test Method
Thickness	ASTM D374
Specific Gravity	ASTM D792
Hardness	IRHD / ISO 7619
Color	Visual
Tensile Strength	ASTM D412 / 1458
Elongation	ASTM D412 / 1458
Volume Resistivity	ASTM D257
Breakdown Voltage	ASTM D149
Dielectric Strength	ASTM D149
Dielectric Constant	ASTM D150
Dielectric Factor	ASTM D150
Thermal Conductivity	ASTM D2326 (Hot Wire)
Recommended Operating Temp.	(Recommended Temp.)
Flame Retardant	UL94

SARCON® GAP FILLER TYPE

Highly Conformable and High Heat Conducting Gel Materials

SARCON® Thermal Gap Filler Pads are highly conformable and high heat conducting gel materials in a versatile sheet form. They easily fit and adhere to most all shapes and sizes of components, including protrusions and recessed areas.

Features

- Gap filler materials are supplied in a fully cured state and remain pliable, easily conforming to minute surface irregularities.
- The basic Gap Filler Pad series can be further enhanced for special handling and die-cutting requirements.
- UL94 V-0 certified. (with exceptions → see P.15)

Recommended Application

You can choose suitable Gap Filler Pad thickness each gap

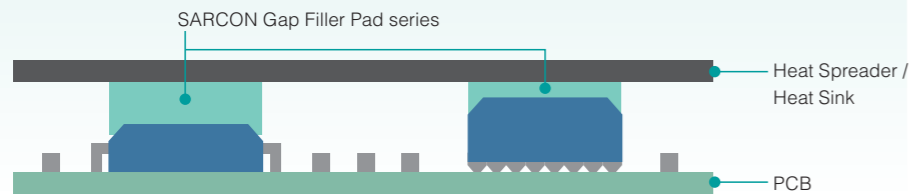

In areas where space between surface is uneven or varies and where surface textures are a concern regarding efficient thermal transfer, the supple consistency of Gap Filler Pad is excellent for filling air gaps and uneven surfaces.

Compression Load Correlation of Fujipoly TIM Pad Products

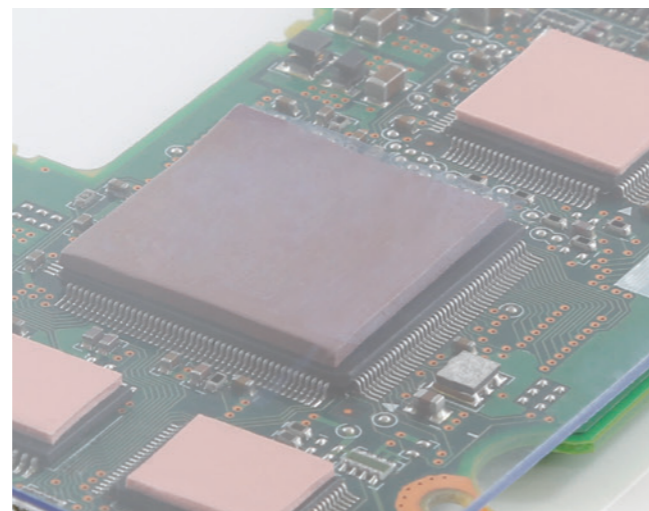
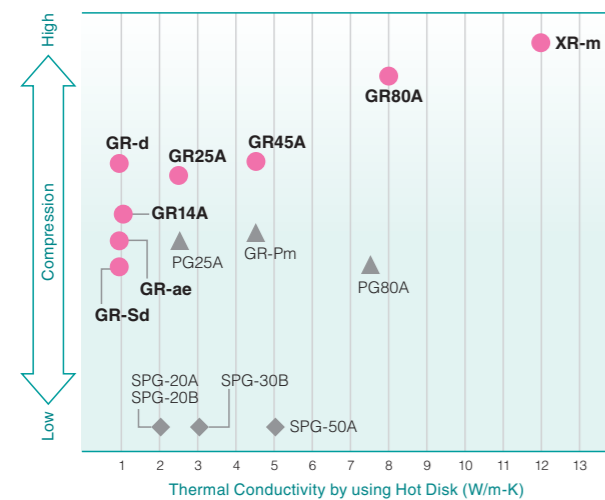

Configuring a Part Number of Gap Filler Type -1

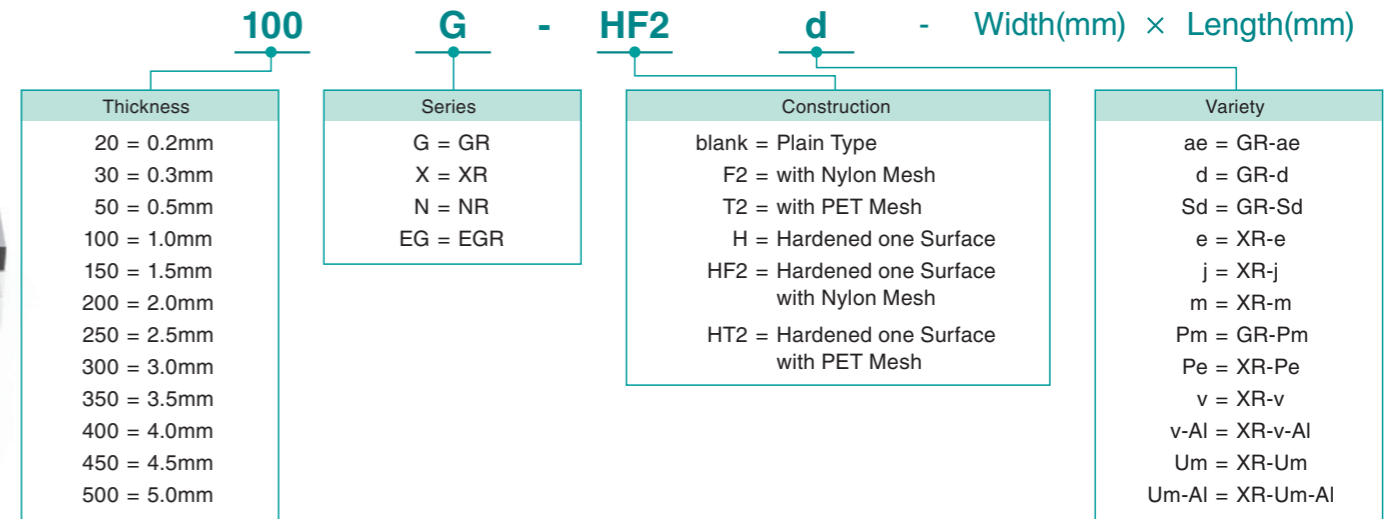

Configuring a Part Number of Gap Filler Type -2 (New ver.)

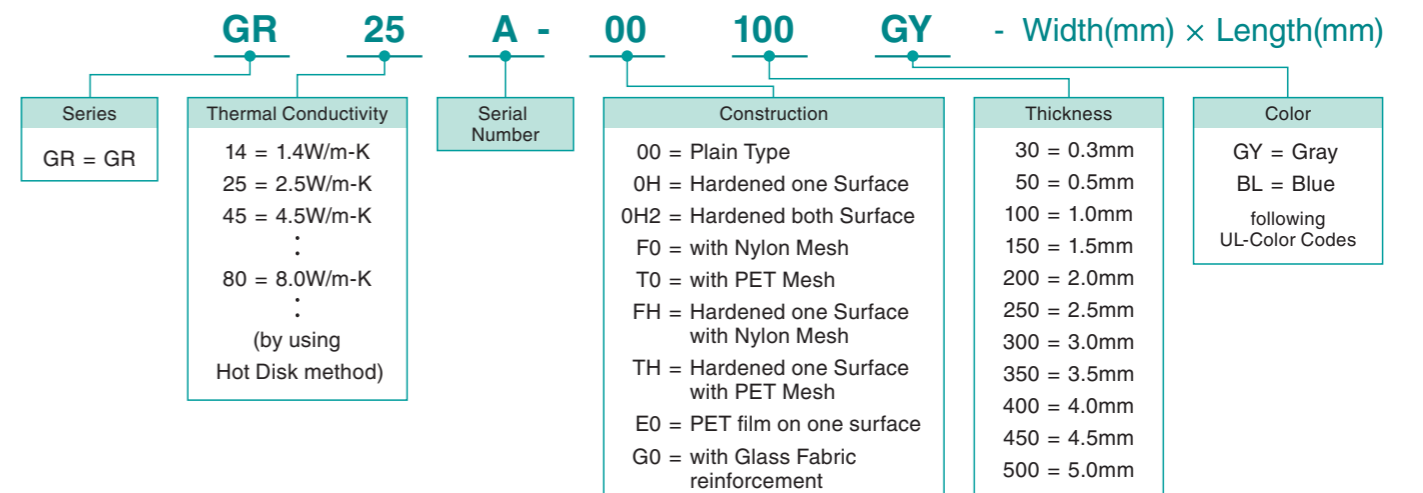

Variety

	Plain Type	with Mesh	Hardened Surface	Hardened Surface with Mesh	PET film on one surface	with Glass Fiber Cloth
construction						
characteristics	General purpose silicone compound	Same general purpose silicone compound as above plus mesh reinforcement stiffener to prevent stretching; i.e., elongation of die-cut holes.	Same general purpose silicone compound as above plus additional hardening of the top surface to facilitate handling and installation during complex assemblies.	Same general purpose silicone compound as above plus additional hardening of the top surface to facilitate handling and installation during complex assemblies, and mesh reinforcement stiffener to prevent stretching; i.e., elongation of die-cut holes.	Same general purpose silicone compound as above plus additional PET film on one surface to facilitate Electric Isolation.	Same general purpose silicone compound as above plus glass fiber cloth reinforcement stiffener to prevent stretching with flame retardant.

Mesh; Nylon Mesh : product's thickness of 0.5 mm or more
 PET Mesh : product's thickness of less than 0.5 mm

SARCON® GAP FILLER TYPE

Standard Gap Filler Pads

Construction

1) Plain Type

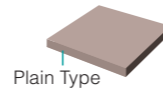

2) with Mesh

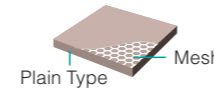

3) Hardened Surface

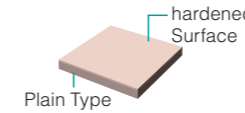

4) Hardened Surface with Mesh

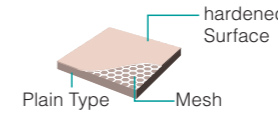

5) PET film on one surface

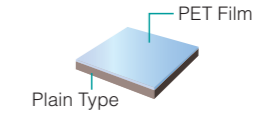

6) with Glass Fiber Cloth

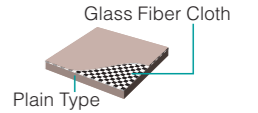

Typical Product Properties

Test Properties	Unit	Standard Gap Filler Pads								High Performance Gap Filler Pads		Test Method		
		GR-ae	GR-d	GR-Sd		GR14A	GR25A	GR45A		GR80A	XR-m			
Physical Properties	Construction	(See P.16)	1) 2) 3) 4) 5) 6)	1) 2) 3) 4) 5)	3)		1) 3) 5) 6)	1) 2) 3) 4) 5) 6)	1) 3) 5)		1) 3)	1)	-	
	Thickness*	mm	0.3 to 5.0	0.5 to 5.0	2.0 to 5.0		0.5 to 5.0	0.3 to 5.0	0.5, 1.0	1.5 to 5.0	0.3 to 3.0	0.3 to 2.0	ASTM D374	
	Specific Gravity	-	2.0	2.6	2.5		2.0	2.6	3.2		3.3	3.2	ASTM D792	
	Hardness	Shore OO	15	50	15		25	50	60	43	75	72	ASTM D2240	
	Color	-	Apricot	Gray	Dark Gray		Gray	Gray	Gray		Gray	Gray	Visual	
	Elongation	%	300	100	230		225	200	50		50	40	ASTM D412	
Electrical Properties	Volume Resistivity	Ohm-m	1x10 ¹²	1x10 ¹²	1x10 ⁹		1x10 ¹¹	1x10 ¹¹	1x10 ¹¹		1x10 ¹¹	1x10 ¹¹	ASTM D257	
	Breakdown Voltage	kV/mm	17	18	10		14	15	17		15	10	ASTM D149	
	Dielectric Strength	kV/mm	11	14	10		11	9	14		8	7	ASTM D149	
	Dielectric Constant	50Hz		4.91	5.82	6.44		4.82	6.60	8.98		9.54	4.8	ASTM D150
		1kHz		4.65	5.56	6.20		4.31	6.05	8.63		8.82	4.7	
		1MHz		4.50	5.46	5.97		4.04	5.74	8.05		7.92	4.8	
Dissipation Factor	50Hz		0.051	0.048	0.024		0.092	0.083	0.025		0.063	0.058	ASTM D150	
	1kHz		0.020	0.015	0.015		0.042	0.030	0.022		0.044	0.003		
	1MHz		0.004	0.003	0.007		0.006	0.005	0.007		0.014	0.001		
Thermal Properties	Thermal Conductivity unit : W/m-K	ASTM D5470	-	-	-		-	-	-		13.0	17.0	ASTM D5470	
		Hot Wire	1.5	1.5	1.5		1.6	2.8	6.0		-	-	ASTM D2326	
		Hot Disk	1.3	1.3	1.3		1.4	2.5	4.5		8.0	11.0	ISO/CD 22007-2	
	Recommended Operating Temp.	°C	-40 to +150	-40 to +150	-40 to +150		-40 to +150	-40 to +150	-40 to +150		-40 to +150	-40 to +150	-	
		°F	-40 to +302	-40 to +302	-40 to +302		-40 to +302	-40 to +302	-40 to +302		-40 to +302	-40 to +302	-	
Flame Retardant	-	V-0**	V-0***	V-1		V-0	V-0	V-0		V-0	V-0	UL94		

a) Hardness : The highest value by using Shore OO.

b) Thermal Conductivity : Measured by using ASTM D5470 modified, refer to Fujipoly Test method "FTM P-3030". → See P.32

: Measured by using Hot Wire method, refer to Fujipoly Test method "FTM P-1620". → See P.31

: Measured by using Hot Disk method, refer to Fujipoly Test method "FTM P-1612". → See P.31

* Some details of thickness. → See P.30

** 50G-F2ae, 50G-HF2ae : V-1

*** GR-d: Flame Retardant

50 up to 500G-d : V-0 50 up to 500GH-d : V-0

50 up to 250G-Fd : V-1 50 up to 250G-HFd : V-1

300G-Fd : V-0 300G-HFd : V-0

[Note]

GR25A : replacement for GR-L

GR45A : replacement for GR-m

GR80A : replacement for XR-e and XR-j

Thermal Resistance

unit : K-cm²/W (K-in²/W)

Pressure	GR-ae				GR-d				GR-Sd			GR14A				GR25A				GR45A				GR80A				XR-m			
	50G-ae	100G-ae	200G-ae	400G-ae	50G-d	100G-d	200G-d	400G-d	200G-Sd	300G-Sd	400G-Sd	00-50GY	00-100GY	00-200GY	00-400GY	00-50GY	00-100GY	00-200GY	00-400GY	00-50GY	00-100GY	00-200GY	00-400GY	0H-30GY	0H-50GY	00-100GY	00-200GY	30X-m	50X-m	100X-m	200X-m
100kPa /14.5psi	4.1 (0.63)	6.1 (0.94)	9.7 (1.51)	13.9 (2.16)	4.5 (0.69)	6.6 (1.03)	9.8 (1.52)	21.0 (3.25)	9.6 (1.48)	11.6 (1.79)	14.2 (2.20)	3.9 (0.61)	6.3 (0.97)	9.9 (1.53)	15.9 (2.46)	2.0 (0.31)	3.7 (0.57)	6.7 (1.03)	11.6 (1.79)	1.8 (0.28)	2.4 (0.37)	3.6 (0.56)	6.2 (0.95)	0.6 (0.09)	0.8 (0.12)	1.1 (0.17)	2.3 (0.36)	0.4 (0.07)	0.5 (0.08)	0.9 (0.14)	1.7 (0.27)
300kPa /43.5psi	3.2 (0.50)	4.4 (0.69)	6.9 (1.07)	9.9 (1.53)	3.4 (0.53)	5.3 (0.81)	7.3 (1.13)	15.6 (2.42)	7.4 (1.14)	8.3 (1.28)	11.0 (1.70)	3.3 (0.51)	5.2 (0.81)	8.0 (1.24)	12.2 (1.89)	1.6 (0.25)	2.8 (0.44)	5.0 (0.78)	7.7 (1.20)	1.5 (0.24)	2.1 (0.32)	3.1 (0.49)	4.5 (0.70)	0.5 (0.08)	0.7 (0.11)	1.0 (0.16)	2.0 (0.31)	0.3 (0.05)	0.4 (0.06)	0.8 (0.13)	1.5 (0.23)
500kPa /72.5psi	2.8 (0.43)	3.8 (0.58)	5.5 (0.86)	8.1 (1.25)	3.0 (0.46)	4.7 (0.73)	6.2 (0.97)	13.1 (2.03)	7.3 (1.13)	8.2 (1.27)	8.8 (1.37)	3.0 (0.46)	4.7 (0.72)	7.1 (1.10)	10.4 (1.62)	1.5 (0.23)	2.5 (0.39)	4.2 (0.65)	6.5 (1.00)	1.3 (0.21)	1.9 (0.30)	2.7 (0.42)	3.4 (0.53)	0.4 (0.06)	0.7 (0.11)	0.9 (0.14)	1.6 (0.25)	0.2 (0.04)	0.4 (0.06)	0.8 (0.12)	1.4 (0.21)

c) Measured by using ASTM D5470 equivalent (TIM tester 1300), refer to Fujipoly Test method "FTM P-3050". → See P.32

EXTREMELY COMPRESSIBLE GAP FILLER TYPE

Highly Thermally Conductive and Non-Flammable interface materials

SARCON® Silicone Extremely Compressible Gap Filler Type (Putty Type) is a highly conductive and thermally conductive, non-flammable interface materials. The surface consistency is excellent for filling small air gaps and uneven mating surfaces, making reliable contact with various shapes and sizes of components.

Features

- Very low compression force at high compression rate.
- Suitable for gaps as small as 0.3mm or less.
- UL94 V-0 certified.
- Available in three formulations.

Recommended Application

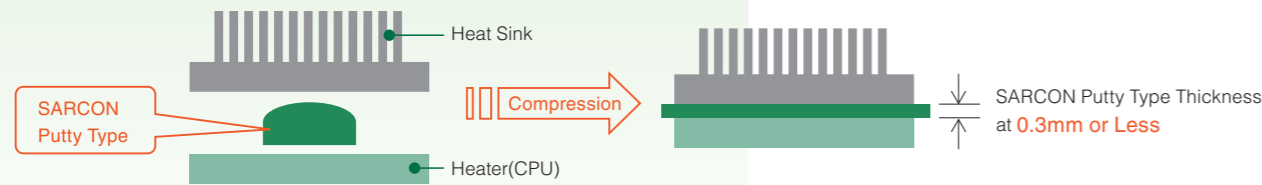

To determine the size and volume of SARCON Putty Type to be used, follow this helpful example:

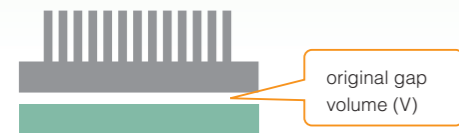

EX.
 $V=45\text{mm}^3$ (0.2mmT x 15mmW x 15mmL)
 Decide Thickness of SARCON depend on the compression force
 e.g. Decided Thickness = 2mm
 $\sqrt{45(V) \times 2 \text{ (Thickness)}} = 4.74\text{mm}$
 → use 5mm x 5 mm @ 2.0mm Thickness

Compression Load Correlation of Fujipoly TIM Pad Products

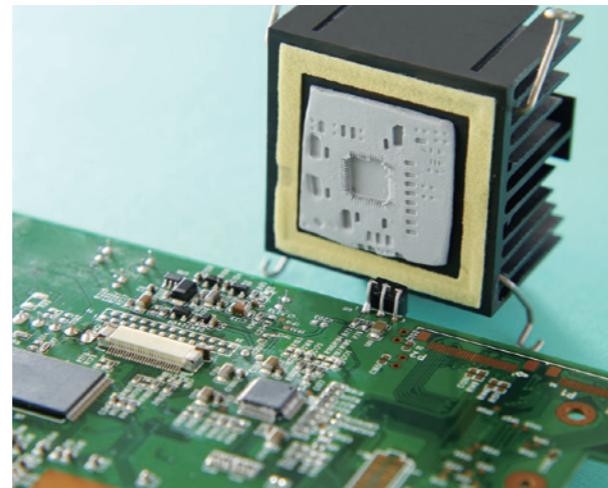
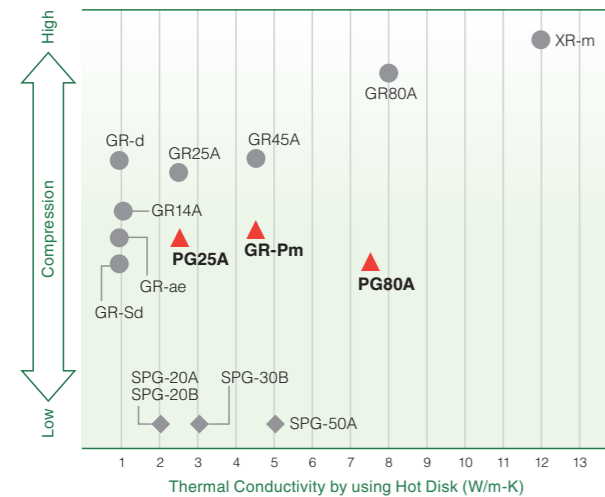

Construction

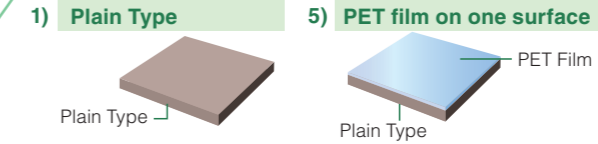

Typical Product Properties

Test Properties	Unit	PG25A	GR-Pm	PG80A	Test Method	
Physical Properties	Construction	(See diagram above)	1) 5)	1)	-	
	Thickness*	mm	1.0 to 5.0	1.5 to 2.5	0.5 to 2.0	ASTM D374
	Specific Gravity	-	2.6	3.2	3.3	ASTM D792
	Color	-	Gray	Dark Radish Gray	Blue	Visual
Electrical Properties	Volume Resistivity	Ohm-m	1×10^{11}	1×10^{12}	1×10^{11}	ASTM D257
	Breakdown Voltage	kV/mm	18	18	12	ASTM D149
	Dielectric Strength	kV/mm	10	13	-	ASTM D149
	Dielectric Constant	50Hz	7.21	7.37	9.28	ASTM D150
		1kHz	6.73	7.31	8.58	
		1MHz	6.25	7.34	7.76	
	Dissipation Factor	50Hz	0.059	0.010	0.048	ASTM D150
1kHz		0.030	0.002	0.039		
1MHz		0.007	0.001	0.015		
Thermal Properties	Thermal Conductivity unit : W/m-K	ASTM D5470	-	-	13.0	ASTM D5470
		Hot Wire	2.8	6.0	-	ASTM D2326
		Hot Disk	2.5	4.5	8.0	ISO/CD 22007-2
	Recommended Operating Temp.	°C	-40 to +150	-40 to +150	-40 to +150	-
		°F	-40 to +302	-40 to +302	-40 to +302	
Flame Retardant	-	V-0	V-0	V-0	UL94	

a) Thermal Conductivity : Measured by using ASTM D5470 modified, refer to Fujipoly Test method "FTM P-3030". → See P.32
 : Measured by using Hot Wire method, refer to Fujipoly Test method "FTM P-1620". → See P.31
 : Measured by using Hot Disk method, refer to Fujipoly Test method "FTM P-1612". → See P.31

* Some details of thickness. → See P.30

Thermal Resistance

unit : K-cm²/W (K-in²/W)

Pressure	PG25A				GR-Pm			PG80A		
	00-100GY	00-200GY	00-300GY	00-400GY	150G-Pm	200G-Pm	250G-Pm	150G-Pm	200G-Pm	250G-Pm
100kPa /14.5psi	2.7 (0.42)	4.9 (0.76)	6.6 (1.02)	8.2 (1.27)	2.9 (0.45)	3.3 (0.51)	4.3 (0.67)	0.5 (0.08)	1.0 (0.16)	1.6 (0.25)
300kPa /43.5psi	1.9 (0.29)	2.9 (0.45)	3.8 (0.59)	5.0 (0.77)	1.2 (0.19)	1.7 (0.26)	2.0 (0.31)	0.3 (0.05)	0.4 (0.06)	0.4 (0.06)
500kPa /72.5psi	1.5 (0.24)	2.2 (0.34)	3.0 (0.47)	4.1 (0.63)	0.8 (0.12)	1.0 (0.16)	1.4 (0.22)	0.2 (0.03)	0.2 (0.03)	0.3 (0.05)

b) Measured by using ASTM D5470 equivalent (TIM tester 1300), refer to Fujipoly Test method "FTM P-3050". → See P.32

Highest Thermal Conductivity EXTREMELY COMPRESSIBLE GAP FILLER TYPE

Highest Thermal Conductivity and Non-Flammable interface materials

SARCON® XR-Um and XR-v is the highest thermally conductive thin film Extremely Compressible Gap Filler Type (Putty Type). The material's putty nature greatly contributes to reduction of contact resistance and consequently to its low thermal resistance. It is a customer friendly material due to its easy application by printing.

SARCON® XR-v-AI, XR-Um-AI has one surface with aluminum film, which enables users to remove the carrier film after installation (before operation) with no-pull-out effect.

Features

- Putty nature enables low contact thermal resistance.
- Low Molecular Siloxane content is very low.
- Has a flame retardant of UL specification 94 V-0.

Constructions

XR-v / XR-v-AI

Item	Size(mm)	Tolerance(mm)
Width	15.0 to 50.0	± 1.5
Length	15.0 to 50.0	± 1.0
Thickness	11X-v 0.11	± 0.03

XR-Um / XR-Um-AI

Item	Size(mm)	Tolerance(mm)
Width	15.0 to 50.0	± 1.5
Length	15.0 to 50.0	± 1.0
Thickness	20X-Um 0.22	± 0.04
	30X-Um 0.30	± 0.06
	40X-Um 0.40	± 0.08
	50X-Um 0.50	± 0.10

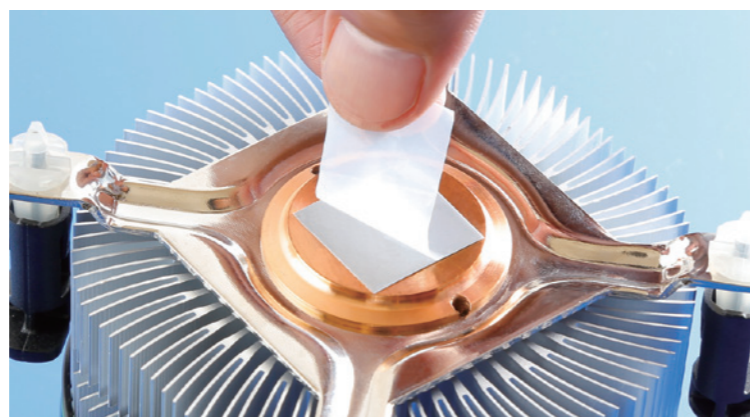
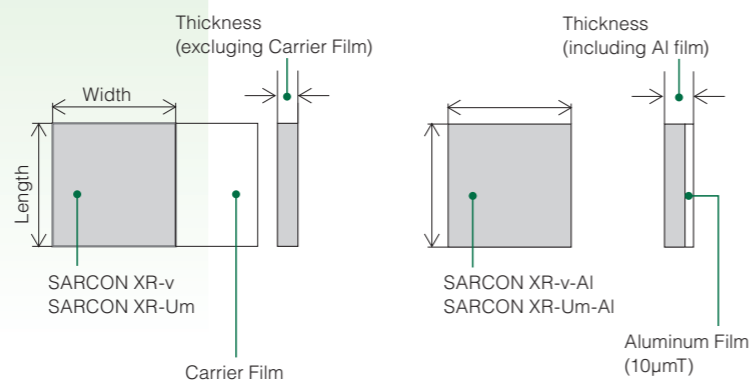

Construction



Typical Product Properties

Test Properties		Unit	XR-v	XR-Um	Test Method
Physical Properties	Construction	(See diagram above)	1) , 7)	1) , 7)	-
	Thickness	mm	0.11	0.22 to 0.5	ASTM D374
	Specific Gravity	-	3.2	3.2	ASTM D792
	Color	-	Apricot	Light Gray	Visual
Electrical Properties	Dielectric Constant	50Hz	7.64	9.49	ASTM D150
		1kHz	7.30	8.19	
		1MHz	7.29	7.71	
	Dissipation Factor	50Hz	0.137	0.180	ASTM D150
		1kHz	0.015	0.052	
		1MHz	0.005	0.005	
Thermal Properties	Thermal Conductivity unit : W/m-K	ASTM D5470	11.0	17.0	ASTM D5470
		Hot Disk	6.6	11.0	ISO/CD 22007-2
	Recommended Operating Temp.	°C	-40 to +150	-40 to +150	-
		°F	-40 to +302	-40 to +302	
Flame Retardant*	-	V-0	V-0	UL94	

a) Thermal Conductivity : Measured by using ASTM D5470 modified, refer to Fujipoly Test method "FTM P-3030". → See P.32
: Measured by using Hot Disk method, refer to Fujipoly Test method "FTM P-1612". → See P.31

* XR-v-AI, XR-Um-AI: V-0 equivalent.

Thermal Resistance

unit : K-cm²/W (K-in²/W)

Pressure	XR-v		XR-Um					
	11X-v	11X-v-AI	20X-Um	30X-Um	50X-Um	20X-Um-AI	30X-Um-AI	50X-Um-AI
100kPa /14.5psi	0.13 (0.02)	0.38 (0.06)	0.16 (0.02)	0.20 (0.03)	0.36 (0.06)	0.29 (0.04)	0.35 (0.05)	0.50 (0.08)
300kPa /43.5psi	0.09 (0.01)	0.24 (0.04)	0.12 (0.02)	0.17 (0.03)	0.31 (0.05)	0.25 (0.04)	0.28 (0.04)	0.38 (0.06)
500kPa /72.5psi	0.08 (0.01)	0.17 (0.03)	0.11 (0.02)	0.15 (0.02)	0.28 (0.04)	0.22 (0.03)	0.26 (0.04)	0.31 (0.05)

b) Measured by using ASTM D5470 equivalent (TIM tester 1300), refer to Fujipoly Test method "FTM P-3050". → See P.32

FORM IN PLACE GAP FILLER TYPE

Highly Thermally Conductive and Electricity Insulative Silicone Compound

SARCON® Form in Place Gap Filler TYPE is a highly conformable / thermally conductive type silicone compound. It provides a thermal solution for the recent trends of higher frequencies and integration in the development of electronic device. SARCON® Form in Place Gap Filler TYPE easily forms and adheres to most surfaces, shapes, and size of components.

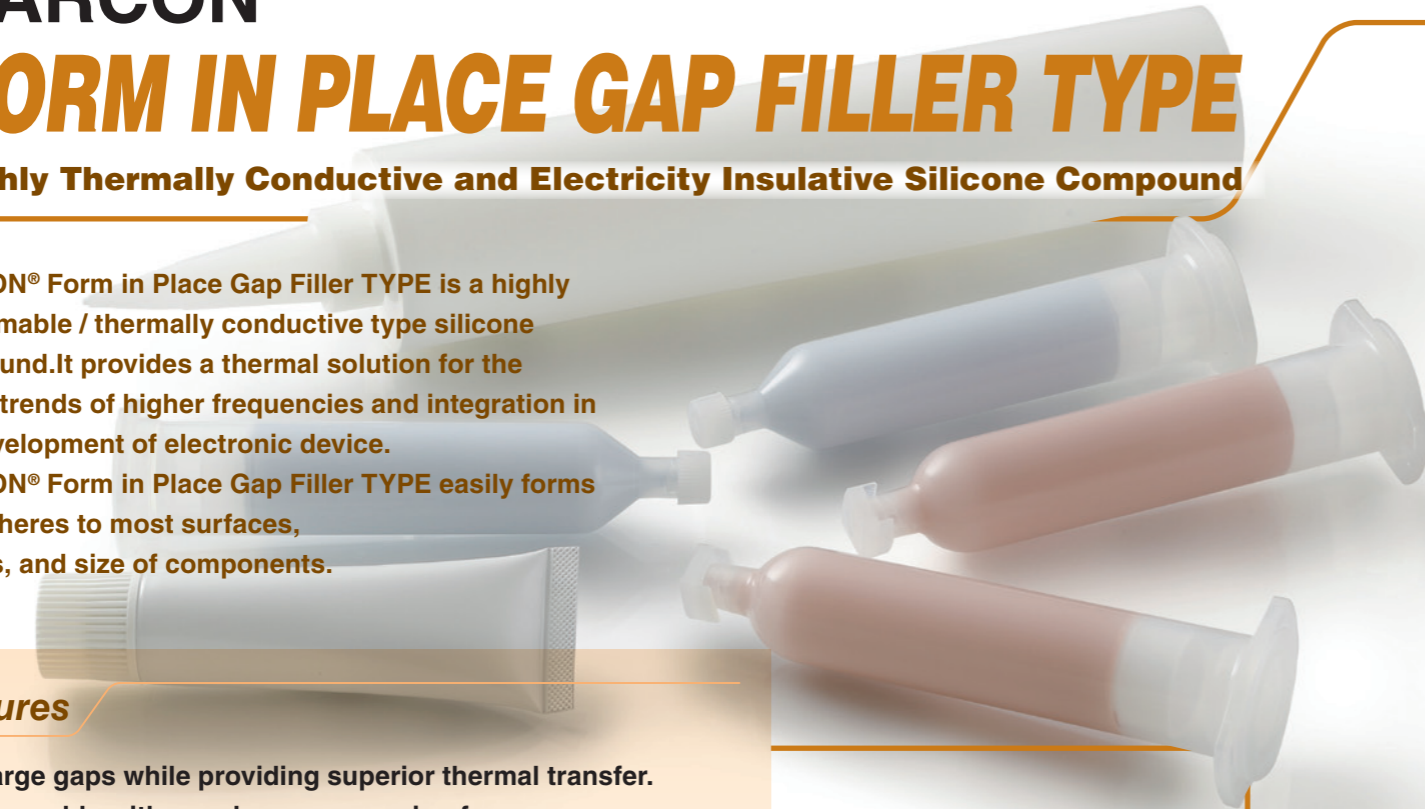

Features

- Fill large gaps while providing superior thermal transfer.
- Conformable with very low compression forces.
- Excellent vibration absorption capabilities.
- Maintains all initial properties across a wide temperature range.
- Used to "Form-in-Place" and remain form stable.
- Requires no heat curing.
- Will not cause corrosion on any metal surface.

Recommended Application

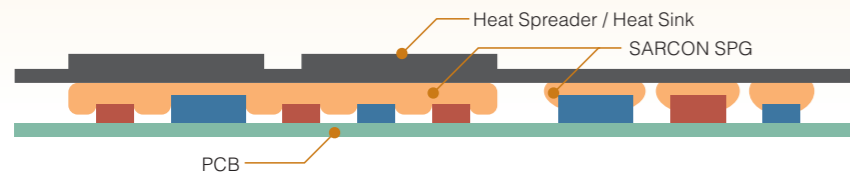

- SARCON Form in Place Gap Filler TYPE is superior to filling gaps as well as dissipating heat.
- Excellent workability / handling with its softness but no dripping and no pumping.

Compression Load Correlation of Fujipoly TIM Pad Products

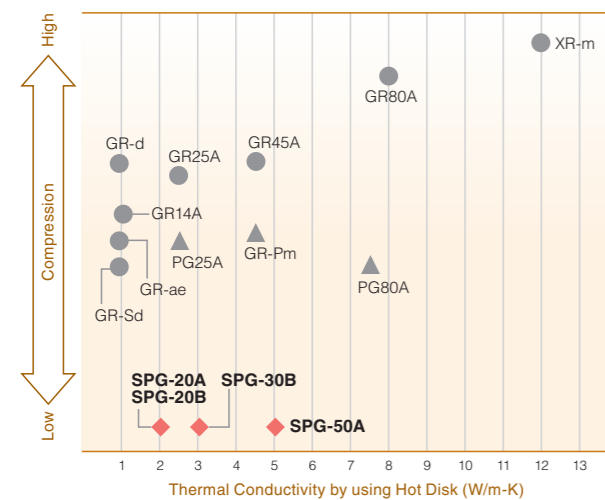

Packaging Options

- Pre-filled syringe : 30cc
- Cartridge : 325cc
- Custom packaging : Available on request

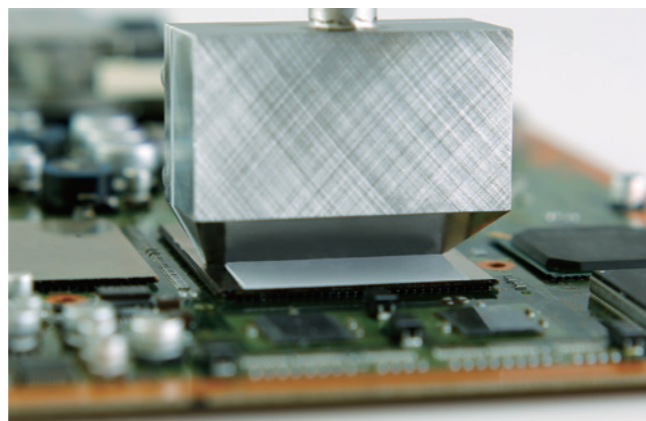

Typical Product Properties

Test Properties	Unit	SPG-20A	SPG-20B	SPG-30B	SPG-50A	Test Method		
Physical Properties	Specific Gravity	-	2.9	2.8	3.2	3.2	ASTM D792	
	Color	-	Light Gray	Light Gray	Apricot	Light Sky Blue	Visual	
	Viscosity	Pa-s	1.0(1/s)	600	1,000	2,600	4,100	ASTM D1824 -1.0(1/s)
			0.5(1/s)	1,000	1,700	4,000	6,900	ASTM D1824 -0.1(1/s)
TGA Weight Loss	wt%	0.03	0.02	0.03	0.06	Fujipoly Original		
Thermal Properties	Thermal Conductivity	W/m-k	2.0	2.1	3.1	5.0	Hot Disk : ISO/CD 22007-2	
	Recommended Operating Temp.	°C	-40 to +150	-40 to +150	-40 to +150	-40 to +150	-	
°F		-40 to +302	-40 to +302	-40 to +302	-40 to +302	-		

a) Viscosity: Measured by Modular Advanced Rheometer System RV1 and the specimen flows to 0.5mm Gap between parallel plates. → See P.34
b) TGA Weight Loss at 150°C(302°F) x24hrs, amount of sample: 2cm³ (0.12in³).
c) Thermal Conductivity : Measured by using Hot Disk method, refer to Fujipoly Test method "FTM P-1612". → See P.31

Thermal Resistance and Reliability

unit : K-cm²/W (K-in²/W)

Initial

Gap	SPG-20A	SPG-20B	SPG-30B	SPG-50A
0.5mm / 0.02in	2.1 (0.33)	1.8 (0.28)	1.3 (0.20)	0.9 (0.14)
1.0mm / 0.04in	-	2.6 (0.40)	2.1 (0.33)	1.7 (0.26)

After 1,000 hours

Test Condition	SPG-20A	SPG-20B	SPG-30B	SPG-50A	
Gap	0.5mm / 0.02in	0.5mm / 0.02in	1.0mm / 0.04in	0.5mm / 0.02in	1.0mm / 0.04in
Initial	2.1 (0.33)	1.8 (0.28)	2.1 (0.33)	0.9 (0.14)	1.7 (0.26)
+70°C	2.1 (0.33)	1.8 (0.28)	2.1 (0.33)	1.0 (0.16)	1.8 (0.28)
+150°C	2.1 (0.33)	1.8 (0.28)	2.6 (0.40)	1.2 (0.19)	1.8 (0.28)
-40°C	2.2 (0.34)	1.8 (0.28)	2.1 (0.33)	1.1 (0.17)	1.8 (0.28)
+60°C /95%RH	2.2 (0.34)	1.8 (0.28)	2.1 (0.33)	0.9 (0.14)	1.7 (0.26)
-40°C ↔ +125°C /30min each	2.6 (0.40)	1.8 (0.28)	2.2 (0.34)	0.9 (0.14)	1.7 (0.26)

e) specimen:

	SPG-20A	SPG-20B	SPG-30B	SPG-50A
Area	3.14cm²	3.14cm²	3.14cm²	3.14cm²
	0.487in²	0.487in²	0.487in²	0.487in²
Weight	Gap:0.5mm / 0.02in 0.46g	0.44g	0.50g	0.50g
	Gap:1.0mm / 0.04in -	0.88g	1.00g	1.00g

f) Measured by using ASTM D5470 modified, refer to Fujipoly Test method "FTM P-3030". → See P.32

Compression Force

unit : N/6.4cm²(psi)

1.0mm Gap	SPG-20A	SPG-20B	SPG-30B	SPG-50A
0.9mm / 0.35in	7 (1.6)	9 (2.0)	11 (2.5)	34 (7.7)
0.8mm / 0.32in	9 (2.0)	11 (2.5)	17 (3.9)	38 (8.6)
0.7mm / 0.28in	12 (2.7)	13 (2.9)	25 (5.7)	45 (10.2)
0.6mm / 0.24in	16 (3.6)	17 (3.9)	36 (8.2)	54 (12.2)
0.5mm / 0.20in	24 (5.4)	22 (5.0)	50 (11.3)	69 (15.6)
Sustain	0 (0.0)	2 (0.5)	5 (1.1)	16 (3.6)

0.5mm Gap	SPG-20A	SPG-20B	SPG-30B	SPG-50A
0.45mm / 0.18in	30 (6.8)	32 (7.3)	36 (8.2)	80 (18.1)
0.40mm / 0.16in	39 (8.8)	42 (9.5)	43 (9.7)	89 (20.2)
0.35mm / 0.14in	48 (10.9)	54 (12.2)	55 (12.5)	100 (22.7)
0.30mm / 0.12in	66 (15.0)	69 (15.6)	61 (13.8)	119 (27.0)
0.25mm / 0.10in	85 (19.3)	86 (19.5)	79 (17.9)	141 (31.9)
Sustain	0 (0.0)	3 (0.7)	7 (1.6)	6 (1.4)

g) Sustain: Sustain 50% at 1 minute later.
h) Measured by using ASTM D575-91(2012) for reference. → See P.34



SARCON® NON-SILICONE GAP FILLER TYPE

Highly Thermally Conductive and Non-Flammable, Non-Silicone materials

Features

- Contains no silicone.
- Lower thermal resistance.
- UL 94V-0.
- Available in sheets for scoring or die-cutting.

Variety

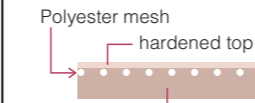
construction	NR-c / Plain Type	NR-Tc / with Mesh	NR-Hc / Hardened Surface	NR-HTc / Hardened Surface with Mesh
				
	100 up to 300N-c (Thickness: 1.0 to 3.0mm)	50 up to 200N-Tc (Thickness: 0.5 to 2.0mm)	100 up to 200N-Hc (Thickness: 1.0 to 3.0mm)	50 up to 300N-HTc (Thickness: 0.5 to 2.0mm)

Typical Product Properties

Test Properties	Unit	NR-c	Test Method
Physical Properties			
Construction	-	(See diagram above)	-
Thickness*	mm	0.5 to 3.0	ASTM D374
Specific Gravity	-	2.1	ASTM D792
Hardness	Shore OO	53	ASTM D2240
Color	-	Light Gray	Visual
Electrical Properties			
Volume Resistivity	Ohm-m	1x10 ⁹	ASTM D257
Breakdown Voltage	kV/mm	11	ASTM D149
Dielectric Constant	50Hz	9.12	ASTM D150
	110Hz	8.55	
	300kHz	5.83	
Dissipation Factor	50Hz	0.152	ASTM D150
	110Hz	0.135	
	300kHz	0.034	
Thermal Properties			
Thermal Conductivity unit: W/m-k	Hot Wire	1.5	ASTM D2326
	Hot Disk	1.3	ISO/CD 22007-2
Recommended Operating Temp.	°C	-40 to +105	-
	°F	-40 to +221	-
Flame Retardant	-	V-0	UL94

a) Hardness : the highest value by using Shore OO.
 b) Thermal Conductivity : Measured by using Hot Wire method, refer to Fujipoly Test method "FTM P-1620". → See P.31
 : Measured by using Hot Disk method, refer to Fujipoly Test method "FTM P-1612". → See P.31

* Some details of thickness. → See P.30

Compression Force

unit : N/6.4cm² (psi)

Compression Ratio	NR-c			
	50N-Tc	100N-c	200N-c	300N-c
10%	581 (131.63)	297 (67.29)	116 (26.28)	71 (16.09)
20%	1277 (289.32)	548 (124.16)	271 (61.40)	168 (38.06)
30%	1886 (427.30)	794 (179.89)	432 (97.88)	276 (62.53)
40%	2490 (564.14)	1077 (244.01)	613 (138.88)	413 (93.57)
50%	3187 (722.05)	1316 (298.16)	826 (187.14)	568 (128.69)
Sustain	1555 (352.30)	445 (100.82)	310 (70.23)	226 (51.20)

c) Sustain: Sustain 50% at 1 minute later.
 d) Measured by using ASTM D575-91(2012) for reference. → See P.34

Thermal Resistance

unit : K-cm²/W (K-in²/W)

Pressure	NR-c			
	50N-Tc	100N-c	200N-c	300N-c
100kPa 14.5psi	4.02 (0.62)	6.60 (1.02)	11.26 (1.75)	16.24 (2.52)
300kPa 43.5psi	3.81 (0.59)	5.05 (0.78)	8.53 (1.32)	12.45 (1.93)
500kPa 72.5psi	3.67 (0.57)	3.96 (0.61)	6.97 (1.08)	10.19 (1.58)

e) Measured by using ASTM D5470 equivalent (TIM tester 1300), refer to Fujipoly Test method "FTM P-3050". → See P.32

SARCON® ELECTROMAGNETIC WAVE ABSORPTION TYPE

Silicone Gap Filler Pad for Absorption of Electromagnetic Wave

Features

- Effective to absorb and damp a wide range of electromagnetic waves.
- Also effective as a high performance thermal interface material.
- Easily filling small gaps of IC chip surface with soft gel texture.
- Good workability to simply insert the product between circuit board.
- Self-adhesive gel surface does not require any adhesive tape for assembly.
- Extremely low level of low molecular siloxane.

Magnetic Characteristics

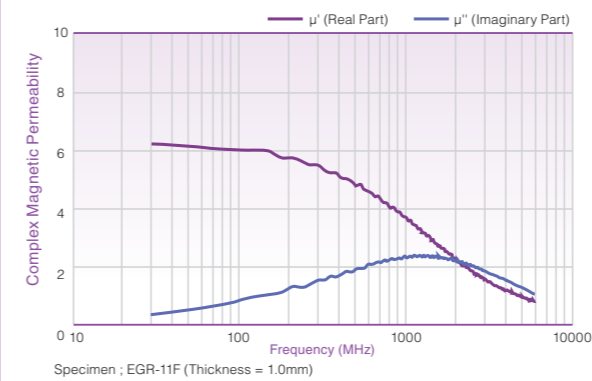

Decoupling Performance in Near Field

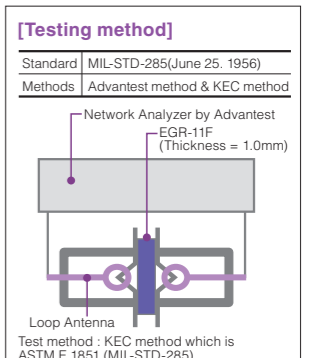
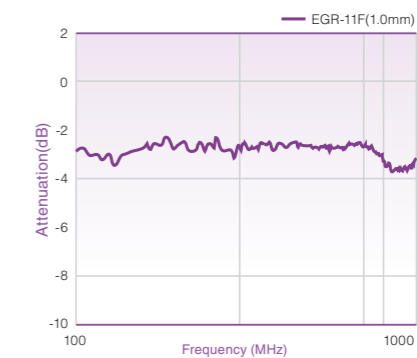

Typical Product Properties

Test Properties	Unit	EGR-11F	Test Method
Physical Properties			
Thickness*	mm	0.5 to 3.0	ASTM D374
Specific Gravity	-	3.1	ASTM D792
Hardness	Shore OO	56	ASTM D2240
Color	-	Dark Gray	Visual
Electrical Properties			
Volume Resistivity	Ohm-m	1x10 ¹⁰	ASTM D257
Breakdown Voltage	V/mm	500	ASTM D149
Dielectric Constant	50Hz	28.33	ASTM D150
	1kHz	27.05	
	300kHz	26.09	
Dissipation Factor	50Hz	0.031	ASTM D150
	1kHz	0.020	
	300kHz	0.005	
Thermal Properties			
Thermal Conductivity unit : W/m-K	Hot Wire	1.0	ASTM D2326
	Hot Disk	0.8	ISO/CD 22007-2
Recommended Operating Temp.	°C	-30 to +120	-
	°F	-22 to +248	-
Flame Retardant	-	V-0	UL94

a) Hardness : the highest value by using Shore OO.
 b) Thermal Conductivity : Measured by using Hot Wire method, refer to Fujipoly Test method "FTM P-1620". → See P.31
 : Measured by using Hot Disk method, refer to Fujipoly Test method "FTM P-1612". → See P.31

* Some details of thickness. → See P.30

Compression Force

unit : N/6.4cm² (psi)

Compression Ratio	EGR-11F			
	50EG-11F	100EG-11F	200EG-11F	300EG-11F
10%	54 (12.2)	41 (9.3)	60 (13.6)	56 (12.7)
20%	288 (65.3)	225 (51.0)	187 (42.4)	110 (24.9)
30%	566 (128.2)	422 (95.6)	309 (70.0)	202 (45.8)
40%	879 (199.1)	590 (133.7)	474 (107.4)	335 (75.9)
50%	1132 (256.5)	813 (184.2)	699 (158.4)	511 (115.8)
Sustain	846 (191.7)	408 (92.4)	320 (72.5)	253 (57.3)

c) Sustain: Sustain 50% at 1 minute later.
 d) Measured by using ASTM D575-91(2012) for reference. → See P.34

Thermal Resistance

unit : K-cm²/W (K-in²/W)

Pressure	EGR-11F			
	50EG-11F	100EG-11F	200EG-11F	300EG-11F
100kPa 14.5psi	6.8 (1.05)	9.6 (1.48)	15.0 (2.33)	24.1 (3.74)
300kPa 43.5psi	6.4 (0.99)	8.8 (1.36)	12.8 (1.98)	20.0 (3.10)
500kPa 72.5psi	6.1 (0.95)	8.4 (1.30)	11.5 (1.79)	18.0 (2.79)

e) Measured by using ASTM D5470 equivalent (TIM tester 1300), refer to Fujipoly Test method "FTM P-3050". → See P.32

SARCON®

THERMALLY CONDUCTIVE GREASE TYPE

SARCON® SG-07SL and SG-26SL are highly thermally conductive, non-reactive silicone-based greases that offer low thermal resistance and maintain a nonflowable composition. Unique binding agents and product formulation ensure the lowest amount of bleed and evaporation. Suited for thin bond line applications. SARCON® SG-07NS and SG-26NS are non-silicone, polysynthetic-based thermal greases that have high thermal conductivity properties. Infused with heat-conductive metal oxides, this nonmigrating material operates consistently in high temperatures. SARCON® nonsilicone greases offer all the benefits of a silicone-based compound without the problem of contamination.



Features

- Silicone and non-silicone formulations.
- Thermal conductivity up to 2.6 W/m-K.
- Low bleed and evaporation.
- No migration for non-silicone formulations over wide temperature range.
- Non-toxic.
- Thin bond lines 25µm(1mil).
- Easy to apply and re-work.

Applications

- Standard dc/dc power converter and dc/ac inverter
- High performance CPUs
- Between any heat generating semiconductor and heat sink
- Custom power modules
- Telecommunications and automotive electronics

Packaging Options

- Pre-filled syringes : 3cc (6g), 10cc (28g), 30cc (72g)
- Jar containers : 1 lb. (454g)
- Custom packaging : Available on request

Typical Product Properties

Test Properties		Unit	SG 07SL	SG 26SL	SG 07NS	SG 26NS	SG 42NS
Physical Properties	Type	-	Silicone	Silicone	Non-Silicone	Non-Silicone	Non-Silicone
	Specific Gravity,@25°C	-	2.2	2.2	2.4	2.2	2.4
	Viscosity*	Pa-s	160	406	250	480	502
		Cps	160,000	406,000	250,000	480,000	502,000
	Flow Rate**	g/min	95	6	75	8	6
	Evaporation, @ 200°C, 24hrs.	%Wt	0.52	0.44	0.68	0.5	0.46
Thermal Properties	Thermal Conductivity	W/m-K	0.75	2.6	0.75	2.6	4.2
Electrical Properties	Volume Resistivity	Ohm-cm	2.1x10 ¹⁴	2.8x10 ¹⁴	1.4x10 ¹⁴	2.1x10 ¹⁴	1.8x10 ¹⁴
		kV/mm	15.4	16.5	12.6	15.7	8.8
	Dielectric Strength	volts / mil	386	412	314	392	219
Operating Temperature Range		°C	-55 to 205	-55 to 205	-55 to 200	-55 to 200	-55 to 200
	°F	-67 to 401	-67 to 401	-67 to 392	-67 to 392	-67 to 392	

* Viscosity Data: Helipath/HB-DV-II+Pro by Brookfield, Speed: 50rpm. ** Flow test: 30cc Syringe, 2.2mm (0.09") orifice at 0.17MPa (25psi).

Volatile Components of SARCON® series

1. Volatile Components of Silicone Materials

The volatile materials from silicone elastomers generally include low-molecular siloxane, moisture and cross-linker. It is very difficult to measure the volume of the moisture or the cross-linker because their amounts in Silicone are too low to be measured. Therefore, we only show the content of low-molecular siloxane.

All silicone elastomers contain some low-molecular siloxane such as D4~D20 (see Fig-1), whose contents are dependent upon each specific manufacturing process or raw materials being used.

(Fig.1: The low-molecular siloxane chemical formula)

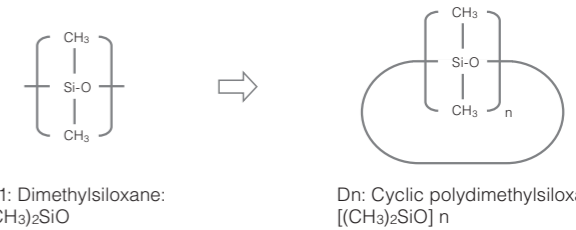

- *An electrical contact failure is, in most cases, caused by a high content of the D13 or lower.
- *The clouding effect of glass or mirror surface is, in most cases, caused by a high content of siloxane which is greater than D13.

We usually post-cure the product, or use volatility-controlled raw material to reduce low-molecular siloxane to a sufficiently low level. SARCON® series is made of the volatility-controlled silicone elastomers.

2. Effect of Low Volatile Siloxane

In the 1980's, there was an electrical defect problem when a motor and a silicone rubber were in closed space or semi closed space. After the investigation, it was found that silica was generated around the electrical contact part due to sparking, and then an electrical defect was caused. The volatile components of siloxane are cracked by the spark on the motor then the silica is generated.

(Fig.2: an electrical defect problem)

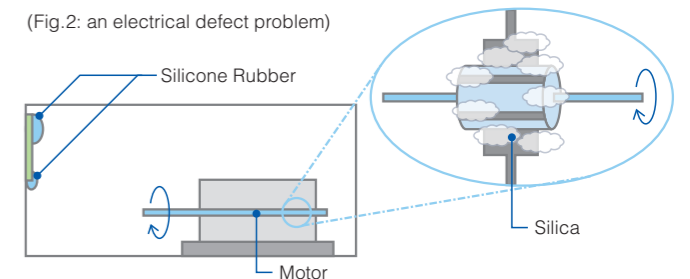

3. Contents of the Low-molecular Siloxane in SARCON® GR • XR series (D4~D20 by wt %)

[Table-1: Typical measurement value]

	RTV *1 (General type)	RTV (C.V. type) *2	SARCON® XR-m	SARCON® XR-Um
	0.2~1.2	0.01~0.06	0.0010	0.0010
Dn (wt %) D 4~20 Total	SARCON® GR80A	SARCON® GR-ae	SARCON® GR-Sd	SARCON® GR25A
	0.0010	0.0010	0.0011	0.0028
	SARCON® GR-Pm	SARCON® GR14A	SARCON® GR45A	SARCON® EGR-11F
	0.0031	0.0034	0.0046	0.0071
	SARCON® GR-d	SARCON® PG80A	SARCON® PG25A	SARCON® XR-v
	0.0099	0.0158	0.0160	0.1000

*1: RTV: Room Temperature Vulcanizing silicone rubber *2: C.V.: Controlled Volatility type

4. Contents of the Low-molecular Siloxane in SARCON® SPG series (D4~D20 by wt %)

[Table-2: Typical measurement value]

Dn (wt %)	SARCON® SPG-20A	SARCON® SPG-20B	SARCON® SPG-30B	SARCON® SPG-50A
D 4~20 Total	0.0026	0.0010	0.0010	0.0043

Test method: Gas Chromatographic Analysis by the extraction, Solvent

- Analytical instrument: GC-14
- Column: DB-1701 (30 m x 0.53 mm I.D.)
- Column Temp: 50 °C(122°F) / 2 min hold → 300°C(572°F) / rate of increase = 10°C(50°F)/min
- Detector: FID (Flame Ionization Detector)
- Injection Temp: 50 °C(122°F)/30sec → 270°C(518°F)
- Syringe Volumes: 2µL
- Detection limits: 0.0010wt%

Compression Force

GAP FILLER TYPE

unit : N/6.4cm² (psi)

Compression Ratio	GR-ae				GR-d				GR-Sd		GR14A			
	50G-ae	100G-ae	200G-ae	300G-ae	50G-d	100G-d	200G-d	300G-d	200G-Sd	300G-Sd	00-50GY	00-100GY	00-200GY	00-300GY
10%	47 (10.6)	41 (9.3)	31 (7.0)	27 (6.1)	142 (32.2)	121 (27.4)	100 (22.7)	60 (13.6)	47 (10.6)	29 (6.6)	74 (16.8)	61 (13.8)	44 (10.0)	29 (6.6)
20%	205 (46.4)	148 (33.5)	84 (19.0)	57 (12.9)	250 (56.6)	198 (44.9)	155 (35.1)	124 (28.1)	89 (20.2)	49 (11.1)	195 (44.2)	135 (30.6)	98 (22.2)	63 (14.3)
30%	363 (82.2)	263 (59.6)	158 (35.8)	94 (21.3)	394 (89.3)	308 (69.8)	249 (56.4)	202 (45.8)	132 (29.9)	77 (17.4)	337 (76.4)	244 (55.3)	166 (37.6)	121 (27.4)
40%	516 (116.9)	386 (87.5)	243 (55.1)	158 (35.8)	558 (126.4)	441 (99.9)	385 (87.2)	309 (70.0)	196 (44.4)	120 (27.2)	512 (116.0)	405 (91.8)	286 (64.8)	198 (44.9)
50%	656 (148.6)	513 (116.2)	353 (80.0)	231 (52.3)	720 (163.1)	626 (141.8)	579 (131.2)	463 (104.9)	297 (67.3)	193 (43.7)	673 (152.5)	568 (128.7)	467 (105.8)	332 (75.2)
Sustain	306 (69.3)	249 (56.4)	185 (41.9)	124 (28.1)	360 (81.6)	340 (77.0)	306 (69.3)	252 (57.1)	142 (32.2)	73 (16.5)	301 (68.2)	296 (67.1)	247 (56.0)	173 (39.2)

Compression Ratio	GR25A				GR45A				GR80A				XR-m			
	00-50GY	00-100GY	00-200GY	00-300GY	00-50GY	00-100GY	00-200GY	00-300GY	0H-30GY	0H-50GY	0H-100GY	0H-200GY	30X-m	50X-m	100X-m	200X-m
10%	108 (24.5)	92 (20.8)	77 (17.4)	70 (15.9)	70 (15.9)	72 (16.3)	52 (11.8)	36 (8.2)	68 (15.4)	106 (24.0)	82 (18.6)	60 (13.6)	33 (7.5)	94 (21.3)	98 (22.2)	112 (25.4)
20%	252 (57.1)	203 (46.0)	156 (35.3)	129 (29.2)	243 (55.1)	291 (65.9)	160 (36.3)	116 (26.3)	193 (43.7)	312 (70.7)	229 (51.9)	183 (41.5)	130 (29.5)	308 (69.8)	329 (74.5)	445 (100.8)
30%	413 (93.6)	342 (77.5)	263 (59.6)	209 (47.4)	470 (106.5)	551 (124.8)	300 (68.0)	216 (48.9)	356 (80.7)	568 (128.7)	468 (106.0)	379 (85.9)	255 (57.8)	572 (129.6)	653 (147.9)	1032 (233.8)
40%	583 (132.1)	505 (114.4)	408 (92.4)	324 (73.4)	703 (159.3)	859 (194.6)	441 (99.9)	308 (69.8)	510 (115.5)	832 (188.5)	698 (158.1)	608 (137.8)	404 (91.5)	836 (189.4)	1051 (238.1)	1621 (367.3)
50%	740 (167.7)	675 (152.9)	569 (128.9)	463 (104.9)	913 (206.9)	1135 (257.1)	582 (131.9)	410 (92.9)	678 (153.6)	1145 (259.4)	930 (210.7)	794 (179.9)	579 (131.2)	1099 (249.0)	1471 (333.3)	2200 (498.4)
Sustain	351 (79.5)	337 (76.4)	285 (64.6)	282 (63.9)	649 (147.0)	667 (151.1)	219 (49.6)	152 (34.4)	660 (149.5)	861 (195.1)	389 (88.1)	319 (72.3)	506 (114.6)	875 (198.2)	882 (199.8)	1523 (345.1)

EXTREMELY COMPRESSIBLE GAP FILLER TYPE

unit : N/6.4cm² (psi)

Compression Ratio	PG25A				GR-Pm			PG80A			
	00-100GY	00-150GY	00-200GY	00-300GY	150G-Pm	200G-Pm	250G-Pm	00-50BL	00-100BL	00-150BL	00-200BL
10%	94 (21.3)	57 (12.9)	42 (9.5)	31 (7.0)	53 (12.0)	52 (11.8)	50 (11.3)	50 (11.3)	42 (9.5)	40 (9.1)	29 (6.6)
20%	153 (34.7)	93 (21.1)	78 (17.7)	58 (13.1)	153 (34.7)	144 (32.6)	123 (27.9)	191 (43.3)	130 (29.5)	95 (21.5)	72 (16.3)
30%	241 (54.6)	155 (35.1)	127 (28.8)	98 (22.2)	265 (60.0)	231 (52.3)	207 (46.9)	337 (76.4)	215 (48.7)	147 (33.3)	111 (25.1)
40%	368 (83.4)	248 (56.2)	202 (45.8)	158 (35.8)	375 (85.0)	314 (71.1)	289 (65.5)	474 (107.4)	292 (66.2)	192 (43.5)	140 (31.7)
50%	533 (120.8)	385 (87.2)	306 (69.3)	243 (55.1)	492 (111.5)	408 (92.4)	371 (84.1)	605 (137.1)	374 (84.7)	231 (52.3)	166 (37.6)
Sustain	212 (48.0)	149 (33.8)	118 (26.7)	99 (22.4)	144 (32.6)	118 (26.7)	76 (17.2)	128 (29.0)	65 (14.7)	46 (10.4)	41 (9.3)

d) Sustain: Sustain 50% at 1 minute later.
e) Measured by ASTM D575-91(2012) for reference. → See P.34

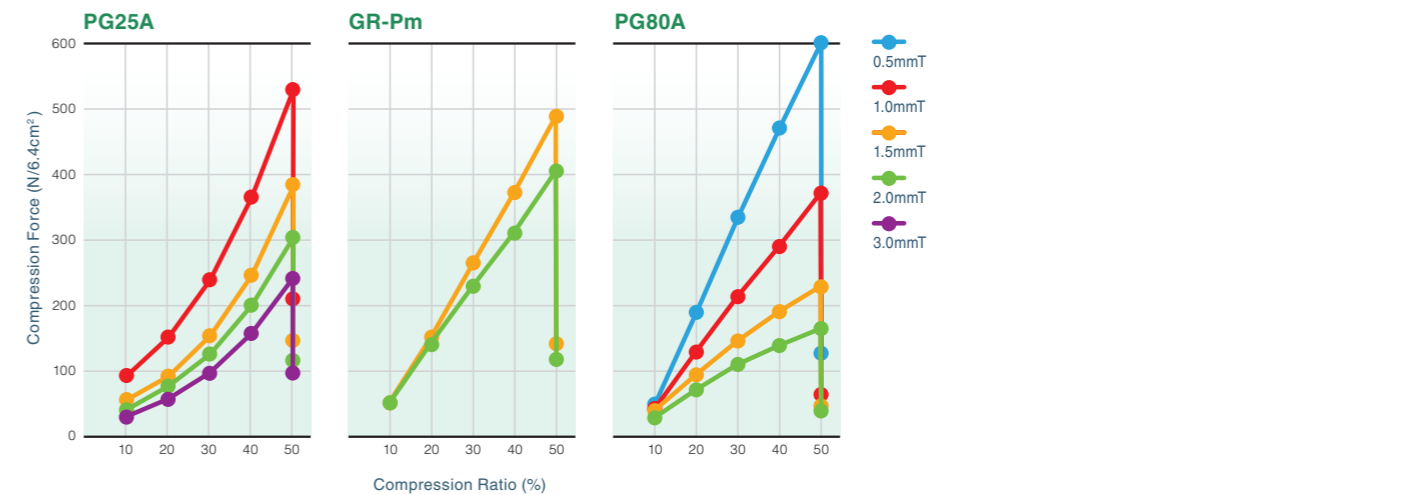
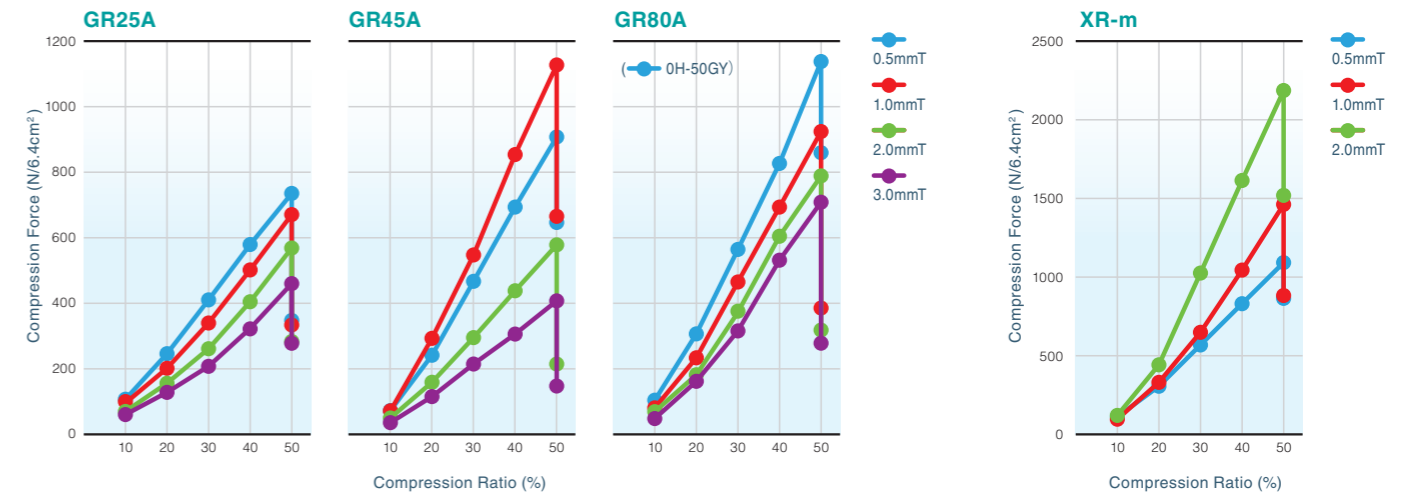
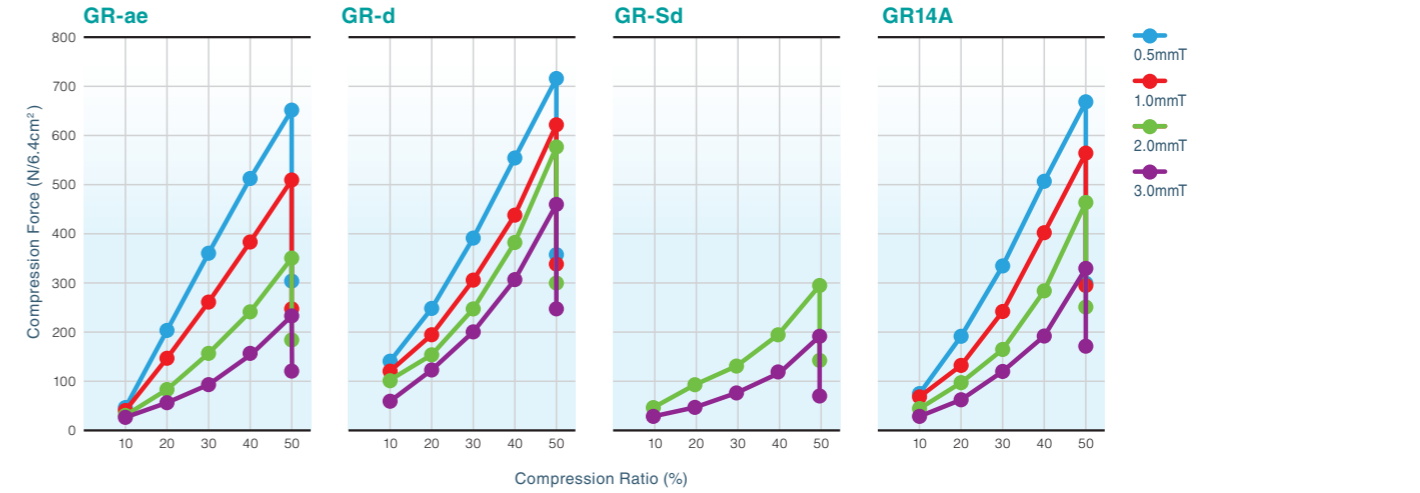

Thickness of SARCON® materials / Standard Type

SARCON®	Construction	Thickness (mm)	Sheet (mm)
QR	30Q	0.3 + 0.1/-0	(see P10)
	45Q	0.45 ± 0.05	
	85Q	0.85 ± 0.05	
TR	30T	0.3 + 0.1/-0	(see P10)
	45T	0.45 ± 0.05	
	85T	0.85 ± 0.05	
HR	30H	0.3 + 0.1/-0	(see P10)
	45H	0.45 ± 0.05	
	85H	0.85 ± 0.05	
YR-a	20Y-a	0.2 ± 0.05	(see P10)
	30Y-a	0.3 + 0.1/-0	
	45Y-a	0.45 ± 0.05	
	85Y-a	0.85 ± 0.05	
YR-b	20Y-b	0.2 ± 0.05	(see P10)
	30Y-b	0.3 + 0.1/-0	
	45Y-b	0.45 ± 0.05	
	85Y-b	0.85 ± 0.05	
GTR	15GTR	0.15 + 0.02/-0.04	(see P10)
	20GTR	0.2 + 0.02/-0.04	
	30GTR	0.3 + 0.1/-0	
GHR	15GHR	0.15 + 0.02/-0.04	(see P10)
	20GHR	0.2 + 0.02/-0.04	
	30GHR	0.3 + 0.1/-0	
GSR	20GSR	0.2 ± 0.05	310 x 310 (see P10)
	30GSR	0.3 + 0.1/-0	
	45GSR	0.45 ± 0.05	
	85GSR	0.85 ± 0.05	
GAR	20GAR	0.2 ± 0.05	(see P10)
	30GAR	0.3 + 0.1/-0	
	45GAR	0.45 ± 0.05	

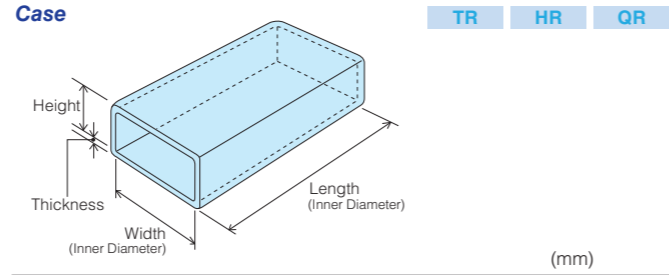

Part Number	Usable Transistors	Thickness	Dimensions	Ordering unit
30T-TO-220-02225, 30H-TO-220-02225	TO-220 type	0.30 ^{+0.1} ₋₀		500 integral multiples
45T-TO-220-01220, 45H-TO-220-01220		0.45 ^{+0.1} _{-0.05}		
90T-TO-220-01220, 90H-TO-220-01220	TO-3P type	0.90 ^{+0.15} _{-0.1}		500 integral multiples
30T-TO-3P-03281, 30H-TO-3P-03281		0.30 ^{+0.1} ₋₀		
50T-TO-3P-02275, 50H-TO-3P-02275	TO-3P type	0.50 ^{+0.05} _{-0.1}		500 integral multiples
90T-TO-3P-01280, 90H-TO-3P-01280		0.90 ^{+0.15} _{-0.1}		
90T-TO-3P-01340, 90H-TO-3P-01340	TO-3P type	0.90 ^{+0.1} _{-0.1}		500 integral multiples

Part Number	Usable Transistors	Thickness	Inner Diameter	Length	Ordering unit
30T-11-25L, 30T-11-30L	TO-220 type	0.30 ^{+0.1} ₋₀	φ 11±1	25±1, 30±1	500 integral multiples
45T-11-25L, 45T-11-30L		0.45±0.05	φ 11±1	25±1, 30±1	
85T-11-25L, 85T-11-30L		0.85±0.05	φ 11±1	25±1, 30±1	
30T-13.5-25L, 30T-13.5-30L	TO-3P type	0.30 ^{+0.1} ₋₀	φ 13.5±1	25±1, 30±1	500 integral multiples
45T-13.5-25L, 45T-13.5-30L		0.45±0.05	φ 13.5±1	25±1, 30±1	
85T-13.5-25L, 85T-13.5-30L		0.85±0.05	φ 13.5±1	25±1, 30±1	

Part Number	Thickness	Length	Ordering unit
30T-36W, 30H-36W, 30Q-36W	0.30 ^{+0.1} ₋₀	36±1	100m integral multiples
30T-85W, 30H-85W, 30Q-85W		85±1	100m integral multiples
45T-36W, 45H-36W, 45Q-36W	0.45±0.05	36±1	50m integral multiples
45T-85W, 45H-85W, 45Q-85W		85±1	
85T-36W, 85H-36W, 85Q-36W	0.85±0.05	36±1	50m integral multiples
85T-85W, 85H-85W, 85Q-85W		85±1	

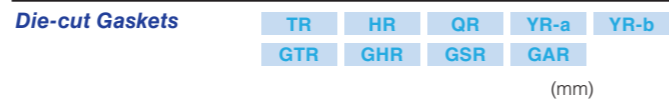

Part Number	Thickness	Dimensions	Ordering unit
30T-TO-220, 30H-TO-220, 30GTR-TO-220, 30GHR-TO-220, 30GSR-TO-220	0.30 ^{+0.1} ₋₀		500 integral multiples
45T-TO-220, 45H-TO-220	0.45±0.05		
30T-TO-3PF, 30H-TO-3PF, 30GTR-TO-3PF, 30GHR-TO-3PF, 30GSR-TO-3PF	0.30 ^{+0.1} ₋₀		500 integral multiples
45T-TO-3PF, 45H-TO-3PF	0.45±0.05		
30T-TO-3, 30H-TO-3, 30GTR-TO-3, 30GHR-TO-3, 30GSR-TO-3	0.30 ^{+0.1} ₋₀		500 integral multiples
45T-TO-3, 45H-TO-3	0.45±0.05		

SARCON®	Construction	Thickness (mm)	Sheet (mm)		
GR-ae	30G-Tae	0.3 ± 0.06	50 x 50		
	50G-ae	0.5 ± 0.05			
	50G-F2ae	50G-HF2ae		0.5 ± 0.15	
	100G-ae	100G-Hae		1.0 ± 0.10	
	100G-F2ae	100G-HF2ae		1.0 ± 0.20	
	150G-ae	150G-Hae		1.5 ± 0.15	
	150G-F2ae	150G-HF2ae		1.5 ± 0.20	
	200G-ae	200G-Hae		2.0 ± 0.20	
	200G-F2ae	200G-HF2ae		2.0 ± 0.30	
	250G-ae	250G-Hae		2.5 ± 0.25	
	300G-ae	300G-Hae		3.0 ± 0.30	
	350G-ae	350G-Hae		3.5 ± 0.35	
	400G-ae	400G-Hae		4.0 ± 0.40	
	450G-ae	450G-Hae		4.5 ± 0.45	
	500G-ae	500G-Hae		5.0 ± 0.50	
GR-d	50G-d	50G-Hd	300 x 200 (Recommended Usable Size; 290 x 190)		
	100G-d	100G-Hd			
	100G-F2d	100G-HF2d			
	150G-d	150G-Hd			
	150G-F2d	150G-HF2d			
	200G-d	200G-Hd			
	200G-F2d	200G-HF2d			
	250G-d	250G-Hd			
	300G-d	300G-Hd			
	350G-d	350G-Hd			
	400G-d	400G-Hd			
	450G-d	450G-Hd			
	500G-d	500G-Hd			
	GR-Sd	200G-Sd		2.0 ± 0.30	300 x 200 (Recommended Usable Size; 290 x 190)
		250G-Sd		2.5 ± 0.30	
300G-Sd		3.0 ± 0.30			
350G-Sd		3.5 ± 0.30			
400G-Sd		4.0 ± 0.40			
500G-Sd		5.0 ± 0.50			
GR14A	GR14A-00-50GY	GR14A-0H-50GY	0.5 ± 0.15	300 x 200 (Recommended Usable Size; 290 x 190)	
	GR14A-00-100GY	GR14A-0H-100GY	1.0 ± 0.20		
	GR14A-00-150GY	GR14A-0H-150GY	1.5 ± 0.20		
	GR14A-00-200GY	GR14A-0H-200GY	2.0 ± 0.30		
	GR14A-00-250GY	GR14A-0H-250GY	2.5 ± 0.30		
	GR14A-00-300GY	GR14A-0H-300GY	3.0 ± 0.30		
	GR14A-00-350GY	GR14A-0H-350GY	3.5 ± 0.35		
	GR14A-00-400GY	GR14A-0H-400GY	4.0 ± 0.40		
	GR14A-00-450GY	GR14A-0H-450GY	4.5 ± 0.45		
	GR14A-00-500GY	GR14A-0H-500GY	5.0 ± 0.50		
GR25A	GR25A-0H2-30GY	0.3 ± 0.10	300 x 200 (Recommended Usable Size; 290 x 190)		
	GR25A-00-50GY	GR25A-0H-50GY		0.5 ± 0.05	
	GR25A-F0-50GY	GR25A-FH-50GY		0.5 ± 0.15	
	GR25A-00-100GY	GR25A-0H-100GY		1.0 ± 0.10	
	GR25A-F0-100GY	GR25A-FH-100GY		1.0 ± 0.20	
	GR25A-00-150GY	GR25A-0H-150GY		1.5 ± 0.15	
	GR25A-F0-150GY	GR25A-FH-150GY		1.5 ± 0.20	
	GR25A-00-200GY	GR25A-0H-200GY		2.0 ± 0.20	
	GR25A-F0-200GY	GR25A-FH-200GY		2.0 ± 0.30	
	GR25A-00-250GY	GR25A-0H-250GY		2.5 ± 0.25	
	GR25A-00-300GY	GR25A-0H-300GY		3.0 ± 0.30	
	GR25A-00-350GY	GR25A-0H-350GY		3.5 ± 0.30	
	GR25A-00-400GY	GR25A-0H-400GY		4.0 ± 0.30	
	GR25A-00-450GY	GR25A-0H-450GY		4.5 ± 0.30	
	GR25A-00-500GY	GR25A-0H-500GY		5.0 ± 0.30	

SARCON®	Construction	Thickness (mm)	Sheet (mm)				
GR45A	GR45A-00-50GY	GR45A-0H-50GY	0.5 ± 0.15	300 x 200 (Recommended Usable Size; 280 x 190)			
	GR45A-00-100GY	GR45A-0H-100GY	1.0 ± 0.20				
	GR45A-00-150GY	GR45A-0H-150GY	1.5 ± 0.20				
	GR45A-00-200GY	GR45A-0H-200GY	2.0 ± 0.30				
	GR45A-00-250GY	GR45A-0H-250GY	2.5 ± 0.30				
	GR45A-00-300GY	GR45A-0H-300GY	3.0 ± 0.30				
	GR45A-00-350GY	GR45A-0H-350GY	3.5 ± 0.35				
	GR45A-00-400GY	GR45A-0H-400GY	4.0 ± 0.40				
	GR45A-00-450GY	GR45A-0H-450GY	4.5 ± 0.45				
	GR45A-00-500GY	GR45A-0H-500GY	5.0 ± 0.50				
GR80A	GR80A-0H-30GY	0.3 ± 0.06	300 x 200 (Recommended Usable Size; 290 x 190)				
	GR80A-0H-50GY	0.5 ± 0.10					
	GR80A-00-100GY	GR80A-0H-100GY		1.0 ± 0.15			
XR-m	30X-m	0.3 ± 0.06	50 x 50				
	50X-m	0.5 ± 0.10					
	100X-m	1.0 ± 0.20					
	150X-m	1.5 ± 0.20					
	200X-m	2.0 ± 0.30					
PG25A	PG25A-00-100GY	1.0 ± 0.15	300 x 200 (Recommended Usable Size; 290 x 190)				
	PG25A-00-150GY	1.5 ± 0.20					
	PG25A-00-200GY	2.0 ± 0.30					
	PG25A-00-250GY	2.5 ± 0.30					
	PG25A-00-300GY	3.0 ± 0.30					
	PG25A-00-350GY	3.5 ± 0.35					
	PG25A-00-400GY	4.0 ± 0.40					
GR-Pm	150G-Pm	1.5 + 0.5/-0	300 x 200 (290 x 190)				
	200G-Pm	2.0 + 0.7/-0					
	250G-Pm	2.5 + 0.7/-0					
	300G-Pm	3.0 + 0.7/-0					
	400G-Pm	4.0 + 0.7/-0					
PG80A	PG80A-00-50GY	0.5 ± 0.10	300 x 200 (Recommended Usable Size; 290 x 190)				
	PG80A-00-100GY	1.0 ± 0.15					
	PG80A-00-150GY	1.5 ± 0.25					
	PG80A-00-200GY	2.0 ± 0.35					
XR-v	XR-v	XR-v-Al	0.11 ± 0.03	(see P19)			
XR-Um	20X-Um	20X-Um-Al	0.22± 0.04	(see P19)			
	30X-Um	30X-Um-Al	0.3 ± 0.06				
	40X-Um	40X-Um-Al	0.4 ± 0.08				
	50X-Um	50X-Um-Al	0.5 ± 0.10				
	100N-c	100N-Hc	1.0 ± 0.10				
NR-c	50N-Tc	50N-HTc	0.5 ± 0.05	300 x 200 (Recommended Usable Size; 290 x 190)			
	100N-c	100N-Hc	1.0 ± 0.10				
	150N-c	150N-Hc	1.5 ± 0.15				
	200N-c	200N-Hc	2.0 ± 0.20				
	250N-c	250N-Hc	2.5 ± 0.25				
	300N-c	300N-Hc	3.0 ± 0.30				
	50EG-11F	100EG-11F	150EG-11F		200EG-11F	250EG-11F	300EG-11F
100EG-11F	1.0 ± 0.20						
150EG-11F	1.5 ± 0.20						
200EG-11F	2.0 ± 0.30						
250EG-11F	2.5 ± 0.30						
300EG-11F	3.0 ± 0.30						

Note: *Some products are not in-stock items. Please contact us for an inventory status.

Test method

Test Method of Thermal Conductivity by ISO / CD 22007-2 Fujipoly standard

Fujipoly Test Method: FTM P-1612 (Hot Disk method)

1. Method
The probe of which the thermal conductivity is known is put on the specimen. Then the hot wire is given constant electric power.

2. Principle
A thermal conductivity is given by the equation below.

$$\lambda = \frac{P_0 \cdot D(\tau)}{\pi^{3/2} \cdot r} \cdot \frac{D(\tau)}{\Delta T(\tau)}$$

- λ : Thermal Conductivity (W/m-K)
- P_0 : Electric Power (W)
- r : A Radius of Sensor (m)
- τ : $\sqrt{\alpha \cdot t / r^2}$
- α : Thermal Diffusivity (m²/s)
- t : Measurement Time (s)
- $D(\tau)$: Function of τ
- $\Delta T(\tau)$: Temperature Increase of Sensor (K)

3. Apparatus

Thermal Conductivity meter	TPA-501
Sensor	RTK Polyimide

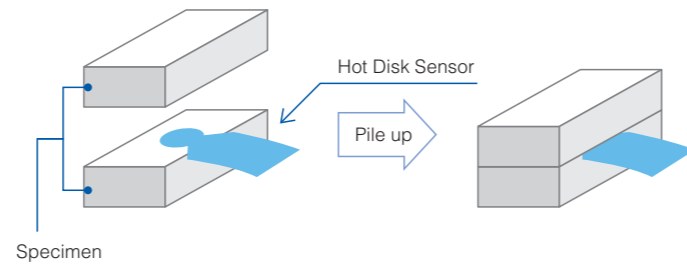

Thermal conductivity is calculated by software for calculation.

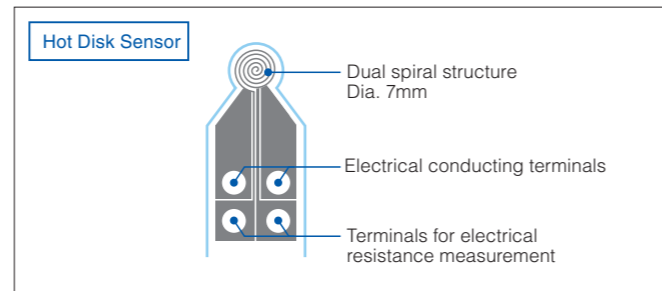

Specimen : Thickness -- 3.0mm sheet, 3 sheets stacked
Width x Length -- 50 x 50 mm

Test Method of Thermal Conductivity by ASTM D2326 equivalent

Fujipoly Test Method: FTM P-1620 (Hot Wire method)

1. Method
The probe of which the thermal conductivity is known is put on the specimen. Then the hot wire is given constant electric power.
Thermal conductivity is calculated by software for calculation.

Specimen : Thickness -- 0.1 to 2.0 mm
Width x Length -- Min. 120 x 60 mm

2. Principle
A thermal conductivity is given by the equation below.

$$\lambda = \frac{Q \cdot \ln(t_2 / t_1)}{4\pi \cdot (T_2 - T_1)}$$

- λ : Thermal Conductivity(W/m-K)
- Q : Quantity of Transferred heat (W/m)
- T_1, T_2 : Temperature at times t_1 and t_2 (K)
- t_1, t_2 : Measurement Time (s)

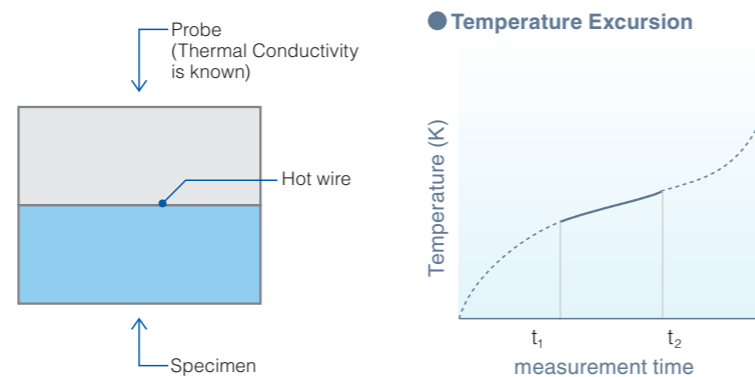

3. Apparatus

Thermal Conductivity meter	QTM-D3
Calculator	PC9801BX2
Probe	QTM-PD1

Test Method of Thermal Resistance by ASTM D5470 equivalent Fujipoly standard

Fujipoly Test Method: FTM P-3050 (TIM Tester method)

1. Principle
Thermal Resistance
 $R_t = \frac{T_1 - T_2}{Q} \cdot S$
 R_t : Thermal Resistance (K-cm²/W)
 T_1 : Heater temperature (K)
 T_2 : AL cooling plate temperature (K)
 Q : Heat flow (W)
 S : Area of the compressed specimen (cm²)

2. Measuring Equipment

Analysis Tech TIM Tester 1300
The Analysis Tech TIM Tester 1300 automatically includes the overall estimated accuracy with the thermal impedance data. This measuring equipment conforms to the test method ASTM D5470, Thermal Transmission Properties of Thermally Conductive Electrical Insulation Materials with the most recent revision.

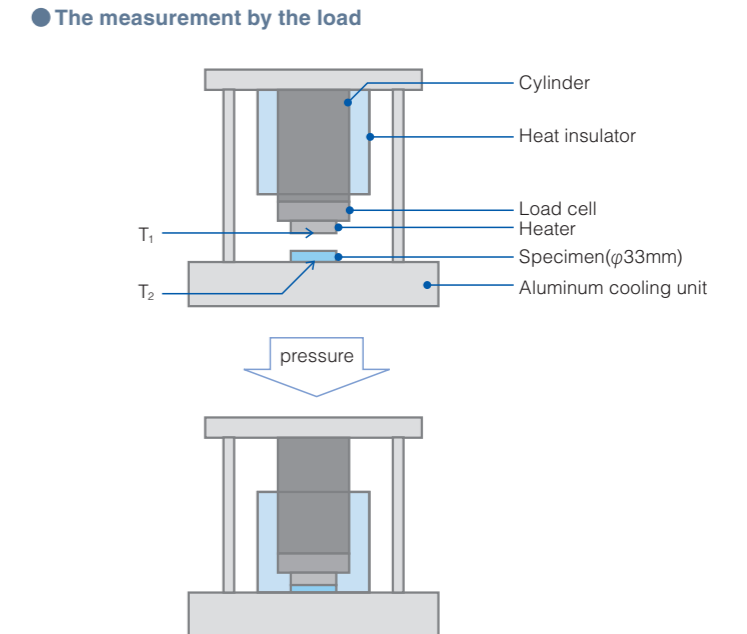

Test Method of Thermal Resistance and Thermal Conductivity by ASTM D5470 modified

Fujipoly Test Method: FTM P-3030 (Guarded Hot Plate method for reference)

1. Principle
Thermal Resistance
 $R_t = (T_1 - T_2 \cdot S / Q) - 0.34$
 R_t : Thermal Resistance (K-cm²/W)
 T_1 : AL heating plate temperature (K)
 T_2 : AL cooling plate temperature (K)
 Q : Heat flow (W)
 S : Area of the compressed specimen (cm²)
0.34 : Thermal resistance revision value of AL plate

Thermal Conductivity
 $\lambda = \frac{T_3 - T_4}{R_{T3} - R_{T4}}$
 λ : Thermal Conductivity (W/m-K)
 T_3 : Thickness of Specimen 1 (cm)
 T_4 : Thickness of Specimen 2 (cm)
($T_3 > T_4$)
 R_{T3} : Thermal Resistance of Specimen 1 (K-cm²/W)
 R_{T4} : Thermal Resistance of Specimen 2 (K-cm²/W)

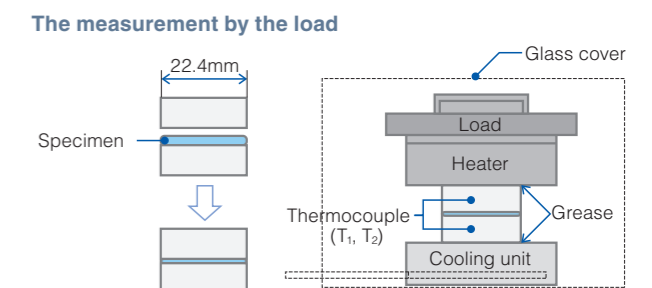
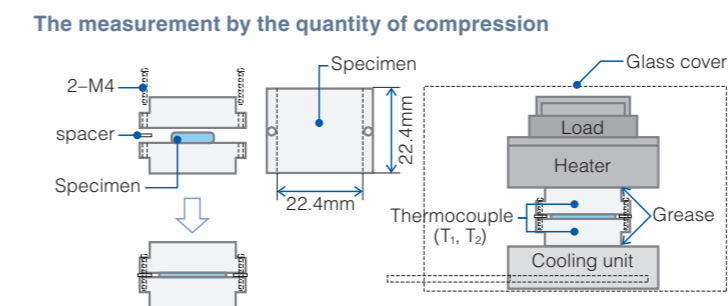

Test method

Test Method for Thermal Resistance by Fujipoly Original

Fujipoly test method: FTM P-3010(TO-3 method) which gives ASTM D5470 equivalent value.

1. Test Method

- 1) Punched-out specimen in TO-3 package is located between a transistor and heat sink, and secured with screws the position (A), using a screwdriver.
- 2) 20 Watt power is applied to the transistor.
- 3) After three minutes, the thermal resistance is calculated based on the following formula (B).

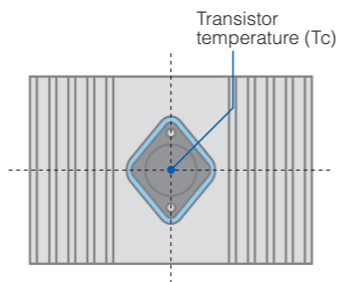

2. Principle

Formula for Thermal Resistance calculation.

$$(B) : Rt = (Tc - Tf) / P_0$$

Rt : Thermal resistance (K-in² / W)
 Tc : Transistor temperature (K)
 Tf : Heat sink temperature (K)
 P_0 : Heat flow (W)

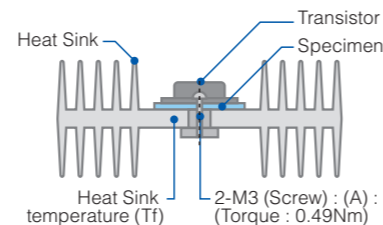

3. Apparatus

Transistor	2SC2245(TO-3 package)
Heat Sink	40CH104L-90-K (manufactured by Ryosan Co., Ltd)
Heat Sensor	2SC1-OHK300 x 532W x J002Y (manufactured by Chino Co., Ltd)
Condition	25°C 60%RH

Fujipoly has been utilizing TIM Tester method and Hot Disk method since Fujipoly defined them as Fujipoly standard.

Current Fujipoly Standard test method;

- Hot Disk method for Thermal Conductivity testing
- TIM-Tester method for Thermal Resistance testing

Back Ground

- Hot Wire method was inefficient to test over 4 W/m-K material for Thermal Conductivity due to unstable Contact Thermal Resistance, and it was worse than TO-3 method in 2000.
- Guarded Heater method was more efficient than TO-3 method, so it was defined as Fujipoly standard method in 2002.
- After that, Hot Disk method and TIM-Tester method were both defined as latest Fujipoly standard method due to so reliable in 2012.

1) Hot Disk Method for Thermal Conductivity (TC) measuring

- [Advantage] The measured TC does not depend on the specimen's surface-roughness and hardness due to wide measuring range. And it is more stable than How Wire method.
- [Disadvantage] Specimen's dimensions, 50 sq-mm x 7mm thickness is so big that the measured TC is a little different from the true one.

2) TIM Tester Method for Thermal Resistance (TR) measuring

- [Advantage] The measured TR can be close to the true TR due each specimen's thickness.
- [Disadvantage] The measured TR depends on the specimen's surface-roughness or hardness, and it is not stable.

3) Hot Wire method for TC measuring.

- [Problem] The measured TC is unstable depending on the specimen's surface-roughness due to fixed-point type thermocouple.

4) Guarded Heater method modified ASTM D 5470 for TR measuring.

- [Problem] The measured TR is lower than the true one because it is impossible to prevent heat dissipation from the Aluminum blocks which hold the specimen. It is also unstable under continuous compression depending on specimen's deformation which comes from small difference in hardness and modulus.

Test Method of Compression Force by ASTM D575-91(2012)

1. Test Method

Compression test in which the force required to cause a specified deflection is determined.

2. Test Condition

Specimen	Dia.28.6mm (1.13in) Thickness is according to each materials Number of specimens; 3pcs
Platens	Dia.28.6mm (1.13in)
Compression Speed	5.0mm/min (0.2in/min) *Fujipoly original speed

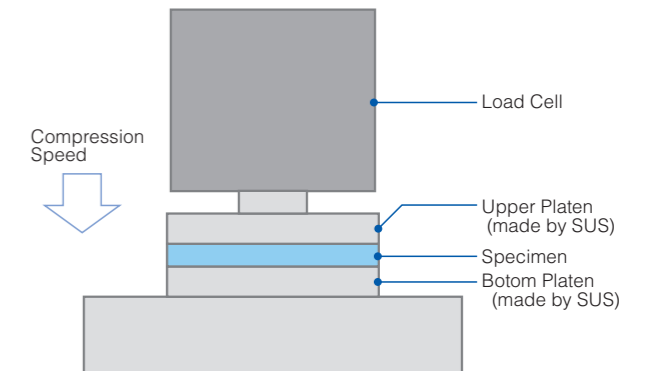

[Note]

Measuring Form in Place Gap Filler type:
The specimen is pressed till setting a gap, and then waiting for the load to settle down.
Setting a gap: 0.5mm or 1.0mm.

Test Method of Viscosity by ASTM D1824 - 95(2010)

1. Test Method

Covers the measurement of SARCON's viscosity at low shear rates.

2. Apparatus

Equipment	HAAKE RotoVisco 1
Sensor	C20/2
Clearance Gap	0.5mm
Rotational Speed	0.5(1/s), 1.0(1/s)

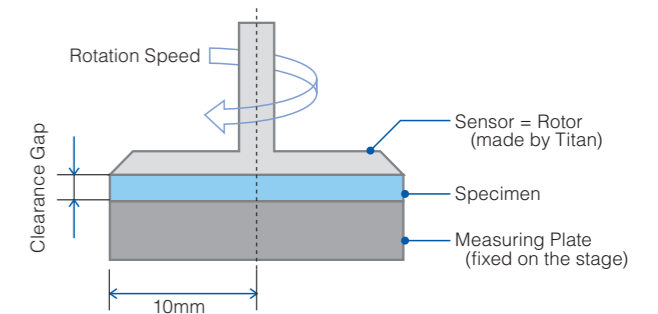



ZEBRA® Features

- High Density, increased number of I/O's
- Low resistance, high current capacity
- Low insertion force, low compression force
- Redundant contact engagement
- High electrical and mechanical reliability
- Chemical stability, degradation resistance
- Cost-effectiveness, ease of assembly

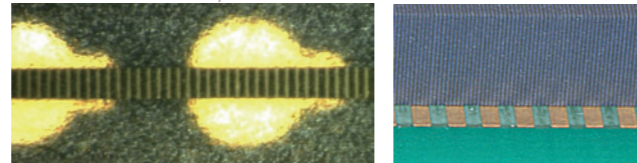

ZEBRA® CARBON / SILVER CONNECTOR SERIES

ZEBRA elastomeric connectors are constructed of alternating parallel layers of electrically conductive and non-conductive silicone elastomer. ZEBRA provides a redundant connection with a minimum of two conductive layers recommended per PC contact pad. The connector is available with insulating barrier or silicone supports.

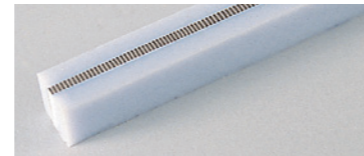

-1) Plain Type (Figure-1)

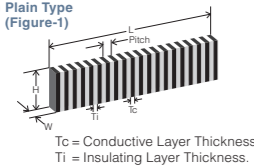

-2) Solid Self-Support Type (Figure-2)

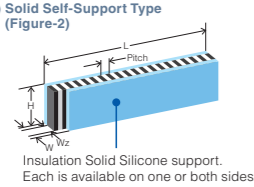

-3) Insulation Barrier Type (Figure-3)

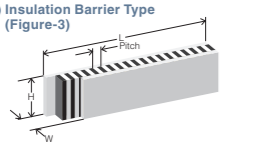

-4) Sponge Self-Support Type (Figure-4)

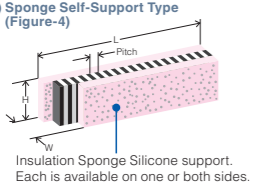

		CZ405/CZ705/2005	CZ410/CZ710/1002	CZ418/2004	CZ610/LT200	SZ100/5002
Metal Particles for Conductive Layers		Carbon	Carbon	Carbon	Carbon	Silver
Contact Area Pitch:	Minimum	0.25mm 0.010in.	0.38mm 0.015in.	0.50mm 0.020in.	0.38mm 0.015in.	0.38mm 0.015in.
Contact Spacing Center-to-Center	Normal	0.050mm 0.002in.	0.10mm 0.004in.	0.18mm 0.007in.	0.10mm 0.004in.	0.10mm 0.004in.
Pitch (Ti+Tc):	Maximum	0.10mm 0.004in.	0.15mm 0.006in.	0.25mm 0.010in.	0.15mm 0.006in.	0.152mm 0.006in.
Sum of the Thickness of an Adjacent Conductive and Non-conductive Layer	Minimum	160/10mm 500/in.	88/10mm 240/in.	45/10mm 140/in.	88/10mm 240/in.	66/10mm 240/in.
Conductive Layers	Minimum	0.010mm 0.0004in.	0.025mm 0.001in.	0.050mm 0.002in.	0.025mm 0.001in.	0.025mm 0.001in.
Individual Conductive and Insulating Layer Thickness	Maximum	0.060mm 0.0024in.	0.10mm 0.004in.	0.15mm 0.006in.	0.10mm 0.004in.	0.075mm 0.003in.
Contact Area Pitch:	Maximum	230mm 9.0in.	230mm 9.0in.	230mm 9.0in.	127mm 5.0in.	127mm 5.0in.
Contact Spacing Center-to-Center	Maximum	4.0 to 61.0mm : ±0.20mm 61.2 to 152.4mm : ±0.38mm 152.6 to 200.0mm : ±0.50mm 200.1 to 230.0mm : ±1.00mm	0.157 to 2.40in. : ±0.008in. 2.41 to 6.00in. : ±0.015in. 6.01 to 7.87in. : ±0.02in. 7.88 to 9.00in. : ±0.039in.	6.35±0.12 to 127.0±0.64mm 0.25±0.005 to 5.0±0.025in.	1.0±0.08 to 12.7±0.18mm 0.04±0.003 to 0.5±0.07in.	
Available Lengths	Maximum	0.38 to 1.0mm : ±0.05mm 1.01 to 2.0mm : ±0.076mm 2.01 to 3.0mm : ±0.127mm above 3.0mm / 0.118in. Consult factory	0.015 to 0.039in. : ±0.002in. 0.040 to 0.079in. : ±0.003in. 0.080 to 0.118in. : ±0.005in.	0.5±0.08 to 2.54±0.13mm 0.02±0.003 to 0.1±0.005in.		
Length (L)		0.5 to 19.0mm : ±0.127mm above 19.0mm / 0.75in. Consult factory	0.02 to 0.75in. : ±0.005in.			
Height (H)		0.38 to 1.0mm : ±0.05mm 1.01 to 2.0mm : ±0.076mm 2.01 to 3.0mm : ±0.127mm above 3.0mm / 0.118in. Consult factory				
Width (W)						
Temperature Range		-40 to +100°C -40 to +212°F		-65 to +125°C -85 to +260°F		-40 to +185°C -45 to +80°F
Current Carrying Capacity			0.005A/mm² pad 0.005A/0.04"x0.04" pad		0.3A/mm² pad 0.3A/0.04"x0.04" pad	
Resistance Between Layers				10 ¹⁰ ohms		

RESISTANCE -
To calculate the resistance of ZEBRA connectors, choose one of the following formulas:

For Carbon ZEBRA	For Silver ZEBRA	Where:
Metric: $R = \frac{60 \times H}{E_w \times W}$ Inches: $R = \frac{2.37 \times H}{E_w \times W}$	Metric: $R = \frac{H \times 0.01}{W \times E_w} + 0.1$ Inches: $R = \frac{H \times 0.0004}{W \times E_w} + 0.1$	W = Width of ZEBRA® Ew = Electrode pad width H = Height of ZEBRA®

ZEBRA® GOLD 8000 CONNECTORS

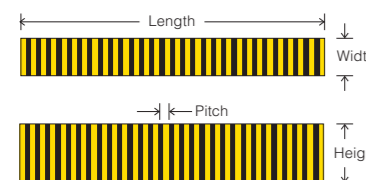

ZEBRA Series 8000 elastomeric connector elements are D-shaped, low durometer silicone elastomers cores around which flat metallic gold-plated conductors are vulcanized in a row parallel to each other. The tips of the metallic conductors are turned upward so that point contact can be effected; in addition, contact is made to the flat area when the connector element is positioned between two printed circuit boards. The point contact will penetrate surface oxides or contaminants which might be present on the surface of the contact pads.

Fujipoly® W CONNECTOR SERIES

Excellent for Land Grid Arrays and similar type interconnects. Extremely accurate silicone rubber electronic connectors with anisotropic conductive properties. Fine metal wires are embedded in the thickness direction of the transparent silicone rubber sheet. The fine metal conductors are gold-plated to ensure low resistance and the ability to withstand a relatively high current flow.

- Features**
- Low electrical resistivity with high sensitivity to compression
 - Large current carrying capacity
 - Electrical conductivity only in thickness "z-axis" direction and non-conductive in "X and Y-axis" direction.
 - Conductive wire are completely plated with gold, ends and surface. Both ends of each wire can protrude from the surfaces of the rubber sheet, therefore electrical reliability of connection is high. (WSL and WSC type)
 - Some design restrictions in thickness depending on the methods of production and application

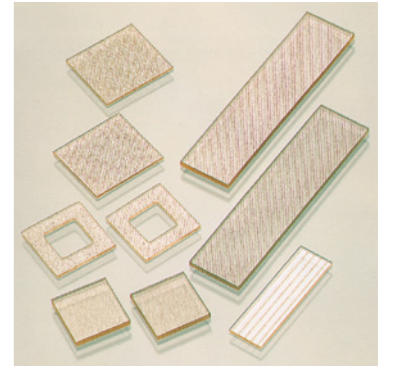

Variety of W connectors.

-1) WSL-Type(Figure-1)

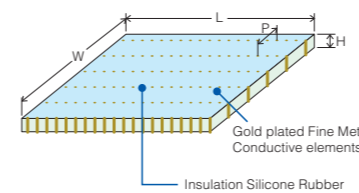

-2) WSC-Type(Figure-2)

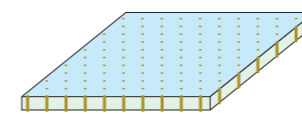

-3) WBC-Type(Figure-3)

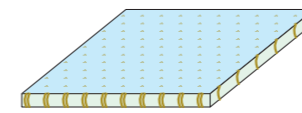

TYPICAL CHARACTERISTICS

Measure	Unit	Thickness		Remarks
		0.5mm	1.0mm	
Continuity Resistance	Ohm @mm²	0.25	0.45	±30%
Current Density	mA/mm²	500		-
Resistance Between Adjacent Conductors	Ohm	10 ¹⁰ or more		C Pattern P=0.35
Light Transmission	%	90		WSL-Type 1.0mm Thickness, P=1.0
Operating Temperature	°C(°F)	-20to+120 (-4to+250)		-

Available Size and Tolerance

	Thickness(H)		Length(L)	Width(W)	Pattern of Conductive elements		Pitch(P)
	nominal: 0.5	nominal: 1.0			Plan View	Side View	
WSL-Type	0.485±0.03mm	0.985±0.03mm	Maximum 76.0mm 3.10in	Maximum 5.0mm 0.20in	Grid pattern	Side view with insulation silicone rubber	1.0mm 0.041in
	0.020±0.001in	0.040±0.001in					
WSC-Type	0.485±0.03mm	0.985±0.03mm	Maximum 50.0mm 2.04in	Maximum 50.0mm 2.04in	Star pattern	Side view with insulation silicone rubber	0.35mm 0.014in
	0.020±0.001in	0.040±0.001in					
WBC-Type	0.490±0.03mm	0.990±0.03mm	Maximum 50.0mm 2.04in	Maximum 50.0mm 2.04in	Star pattern	Side view with insulation silicone rubber	0.35mm 0.014in
	0.020±0.001in	0.040±0.001in					

Fujipoly® Self-fusing Tape



Self-fusing silicone rubber general purpose class H electrical tape. Resiliency and long-term aging properties are excellent; applicable in a very wide temperature range from -45°C to +250°C(-49 °F to 482°F).

Fujipoly® Coextrusion and CUSTOM Silicone Extrusions

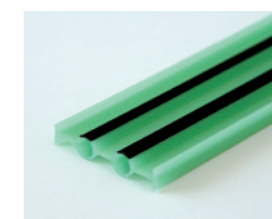

Complex shapes of silicone rubber consisting of different properties such as conductive and non-conductive segments, or color coding. Specifically custom designed to eliminate multiple extruded components by combining different elements into one unitized design. Quick turnaround and cost-effective tooling preparation for your proprietary needs. For engineering assistance and more detailed information, please contact customer service.

OptiCrysta® LGF / LGS

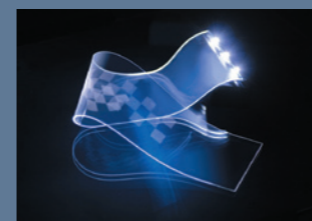

Fujipoly Light Guide Product Series, Opticrysta LGF is a plane emission type of light guiding film made with high transparent silicone rubber. By adjusting the optical design, even illumination across the whole OptiCrysta LGF or selective light up of areas with different light intensity can be achieved. LED light which is shined from the edge of OptiCrysta LGF is transmitted internally and emitted evenly where there are white refracting printing dots. The pattern of the refracting dots can be customized to your needs. And OptiCrysta LGS can be a full surface emitting for backlighting.

ORDERING Information

FUJIPOLY® LOCATIONS

Fuji Polymer Industries Co., Ltd. Sales Department

Eternal Kitayama Build. 3F
1-3-18 Nishiki, Naka-ku,
Nagoya, Aichi 460-0003 JAPAN
tel : +81-52-218-5510 fax : +81-52-218-5515
e-mail : sales@fujipoly.co.jp
Web site : http://www.fujipoly.co.jp/

Aichi Factory

175 Kajiyashiki,
Toyota, Aichi 4700533 JAPAN
tel : +81-565-65-3628 fax : +81-565-65-1857
e-mail : sales@fujipoly.co.jp
Web site : http://www.fujipoly.co.jp/
ISO9001

Fuji Polymer Industries Co., Ltd. Taipei Liaison Office

Room B, 7F., No. 59, Tiansiang Rd.,
Jhongshan District,
Taipei City 10452, Taiwan
tel : +886-2-2586-5771 fax : +886-2-2586-5745
e-mail : fujipolytw@fujipoly.com.tw

Fuji Polymer Industries Co.,Ltd. Korea Liaison Office

Rm404, Daewoo Trump World 2-A #48,
Yeouido Dong, Youngdeungpo Gu,
Seoul, 150-934, Korea
tel : +82-2-785-2801 fax : +82-2-785-2802
e-mail : info@fujipoly.co.kr

Fujipoly America Corporation

900 Millik Street
P.O. Box 119
Carteret, NJ 07008, USA
tel : +1-732-969-0100 fax : +1-732-969-3311
e-mail : info@fujipoly.com
Web site : http://www.fujipoly.com/
ISO9001-2008

Fujipoly America Corporation San Jose Liaison Office

1150 North First Street
Suite 120
San Jose, CA 95112
tel : +1-408-295-5920 fax : +1-408-295-5949
e-mail : info@fujipoly.com

Fujipoly Europe Ltd.

Avant Business Centre, Unit 8,
Third Avenue,
Bletchley Millton Keynes, MK1 1DR UK
tel : +44-1908-277800 fax : +44-1908-277900
e-mail : sales2@fujipolyeurope.co.uk

Fujipoly Europe Ltd. German Liaison Office

Gaertnerstr. 60,
80992, Muenchen, Germany
tel : +49-89-14900240 fax : +49-89-14900211
e-mail : info@nucletron.eu

Fujipoly (Thailand) Co.,Ltd.

55/8 Moo 13 Navanakorn Industrial Estate Phase 4
Phaholyothin Road, Klong Nueng, Klong Luang
Phatumthanee 12120, Thailand
tel : +66-2-529-2732 fax : +66-2-529-2223
e-mail : marketing@fujipoly.co.th
ISO9001 ISO14001

Fujipoly Singapore PTE Ltd.

1001 Jalan Bukit Merah #02-17/20
Singapore 159455
tel : +65-6272-3766 fax : +65-6272-3577
e-mail : info@fujipoly.com.sg
ISO9001

Fujipoly Hong Kong Ltd.

Workshop(F&J), Block 1, 4/FI.
Kwai Tak Industrial Centre,
15-33, Kwai Tak Street, Kwai Chung, N.T., Hong Kong.
tel : +852-2428-3770 fax : +852-2489-9637
e-mail : info@fujipoly.com.hk

Fujipoly Trading(Shenzhen)Co.,Ltd.

Room 2703, Shun Hing square,
Shennan East Road, Luohu district,
Shenzhen 518022, China
tel : +86-755-8237-5494 fax : +86-755-8237-5491

Fujipoly China (Dongguan) Electronics Co., Ltd.

Gaobao Road, The First Industrial Park,
Tutang Estate, Changping Town, Dongguan City,
Guang Dong 523581 China
tel : +86-769-8398-9660 fax : +86-769-8398-9662
e-mail : info@fujipoly.com.hk
ISO9001 ISO14001



SARCON®, ZEBRA® and OptiCrysta®, are registered trademarks of Fujipoly®

STATEMENT OF LIEU OF WARRANTY: All technical information and data in this document is based on tests and is believed to be accurate and reliable. Nevertheless, since the products described herein are not provided to conform with mutually accepted specifications and the use thereof is unknown, the manufacturer and seller of the product do not guarantee results, freedom from patent infringement, or suitability of the product for any application thereof. The manufacturer and seller of the product described in this document will provide all possible technical assistance and will replace any products proven defective. No statement or recommendation made by the manufacturer or seller not contained herein shall have any force of effect unless in conformity with an agreement signed by an officer of the seller or manufacturer. Product testing by the purchaser is recommended in order to confirm expected results. Copyright© 2015 Fujipoly®

Handling Notes

- It is recommended to use the material in up to 30% of compression ratio. Using the material beyond the recommended compression rate may result in excessive silicone oil exudation.
- It is recommended to compress the material with the equal ratio on the whole surface. Partial excessive stress may also result in excessive silicone oil exudation.

Statement of Lieu of Warranty

- Properties of the products may be revised due to some changes for improving performance.
- Properties values in this document are not specification or guaranteed.
- This product is made of silicone, and silicone oil may exude from the product.
- This product is made of silicone, and low molecular siloxane may vaporize depending on operating conditions.
- The product is designed, developed, and manufactured for general industrial use only. Never use for medical, surgical, and/or relating purposes. Never use for the purpose of implantation and/or other purposes by which apart of or whole product remains in human body.
- Before using, a safety must be evaluated and verified by the purchaser.
- Contents described in the document do not guarantee the performances and qualities required for the purchaser's specific purposes. The purchaser is responsible for pre-testing the product under the purchaser's specific.
- Statements concerning possible or suggested uses made herein may not be relied upon, or be constructed, as a guaranty of no patent infringement.